

2025 CATALOGUE GÉNÉRAL

# La MARQUE DES MARQUES RESPONSABLES

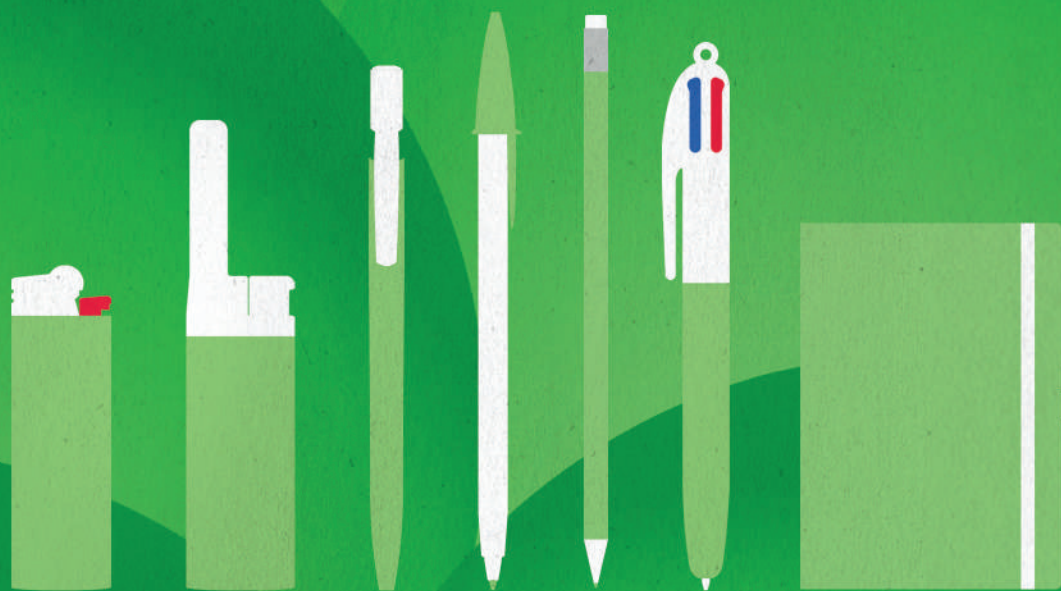



LA MARQUE  
DES MARQUES  
RESPONSABLES



**THINK BIC**

# POURQUOI FAISONS-NOUS CE QUE NOUS FAISONS

---

Notre mission est simple : créer des solutions durables et responsables qui aident les entreprises à prospérer tout en prenant soin de la planète. Depuis 1995, chez BIC Graphic, nous avons constamment pour offrir des solutions créatives, durables et pérennes afin de personnaliser les produits emblématiques de BIC. Animés par un engagement envers des pratiques responsables, nous croyons au pouvoir d'une innovation réfléchie, où chaque produit représente une avancée vers la réduction de notre empreinte carbone. De l'utilisation d'énergie provenant de sources renouvelables à notre collaboration avec des fournisseurs locaux qui partagent nos valeurs, nous veillons à ce que la durabilité ne soit pas seulement un objectif, mais une façon de faire des affaires.

C'est pourquoi, dans cette édition, vous découvrirez nos nouvelles créations fabriquées en Europe, notamment le BIC® EZ Reach™, le BIC® Cristal® Expression, qui écrit jusqu'à 3 km, le BIC® Kids Evolution® Colouring Set et le BIC® Media Clic Biobased, disponible dans des couleurs Pastel tendances. Ces produits reflètent notre engagement continu envers la qualité, l'innovation et la responsabilité.

**BIC Graphic. The Brand of Responsible Brands.**





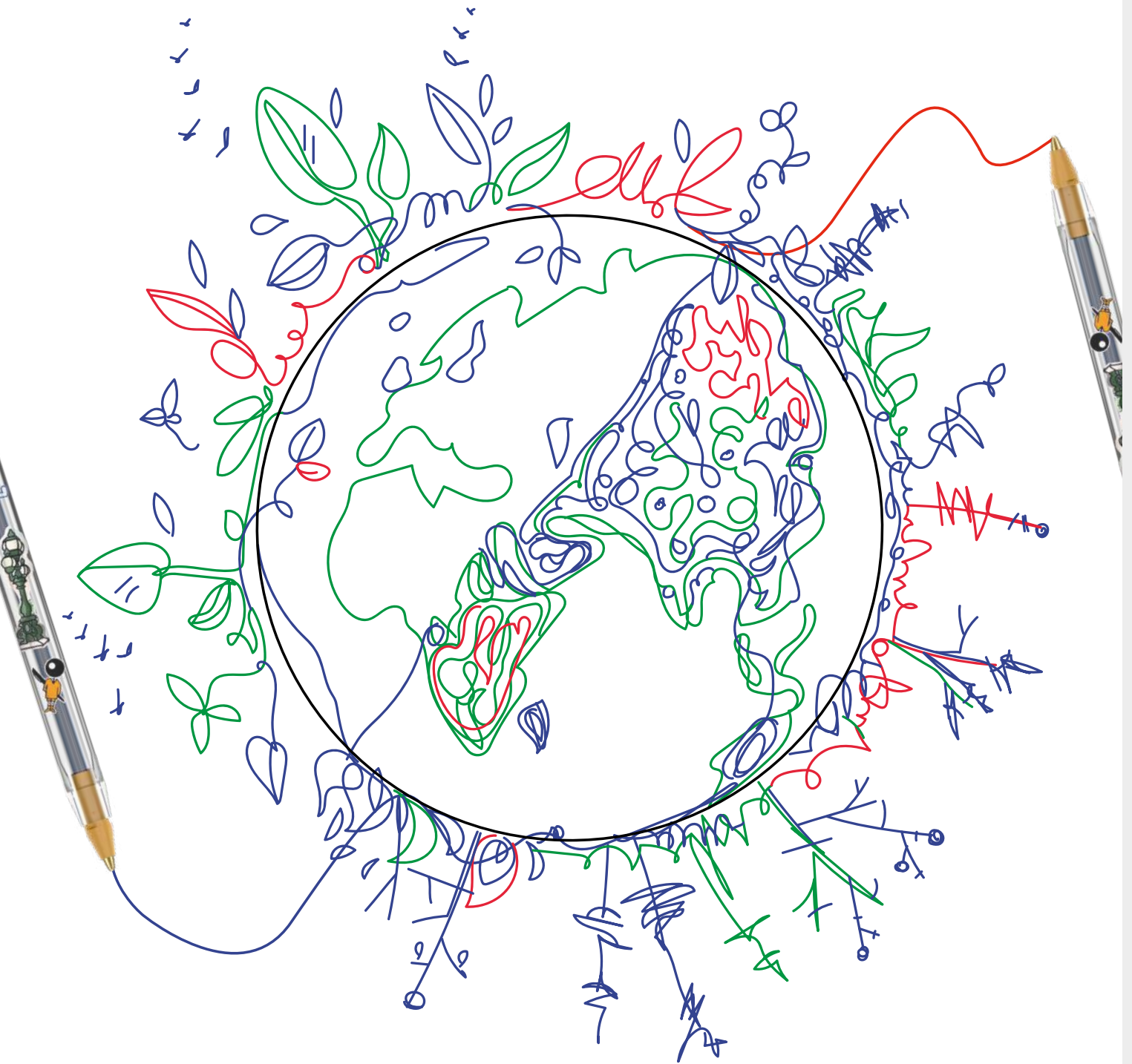

## BIC GRAPHIC

**3**

La marque des marques responsables	2	Produits durables	20
Think BIC	4	75ème anniversaire du BIC® Cristal®	22
Sommaire	6	Nouveautés	24
Explorer BIC Graphic	8	Emballages BIC® Collection	32
La durabilité	12	Techniques d'impression	34
Fabriqué en Europe	18	Gamme britePix™ Digital tout en couleur	36

## INSTRUMENTS D'ÉCRITURE BIC®

**38**

### STYLOS

BIC® Cristal® Expression	40	BIC® 4 Couleurs® Sun	132
BIC® Cristal® Re'New™	44	BIC® 4 Couleurs® Fine	134
BIC® Style	48	BIC® 4 Couleurs® Fluo	136
BIC® Round Stic®	52	BIC® 4 Couleurs® Glacé	138
BIC® Round Stic® BGuard™ antibactérien	54	BIC® 4 Couleurs® Shine	140
BIC® Round Stic® Ecolutions®	55	BIC® 4 Couleurs® Soft	142
BIC® M10® Clic	58	BIC® 4 Couleurs® Wood Style	144
BIC® Media Clic	62	BIC® 4 Couleurs® Flags Collection	146
BIC® Media Clic Ecolutions®	63	BIC® 4 Couleurs® 3+1 <sup>HB</sup>	148
BIC® Media Clic Grip	65		
BIC® Media Clic Grip Ecolutions®	66	<b>STYLOS EN MÉTAL</b>	
BIC® Media Clic BGuard™ antibactérien	72	BIC® Metal Pro	150
BIC® Media Clic BGuard™ antimicrobial Ecolutions®	74		
BIC® Media Clic Biobased Ecolutions®	76	<b>ROLLERS ET GELS</b>	
BIC® Media Clic Biobased BGuard™ antibactérien	80	BIC® Grip Roller	156
BIC® Media Clic Shine	82	BIC® XS Finestyle	158
BIC® Media Clic Glacé	84	BIC® Intensity® Gel Clic	160
BIC® Clic Stic	86		
BIC® Clic Stic Ecolutions®	87	<b>SURLIGNEURS ET MARQUEURS</b>	
BIC® Clic Stic Stylus	90	BIC® Brite Liner® Grip	164
BIC® Clic Stic Stylus Ecolutions®	90	BIC® Velleda® White Board Marker Fine	166
BIC® Super Clip	96	BIC® Velleda® White Board Marker Grip	167
BIC® Super Clip Ecolutions®	97	BIC® Mark-It Permanent Marker	168
BIC® Super Clip Advance	100	BIC® Permanent Marker Ecolutions®	169
BIC® Super Clip Glacé	104		
BIC® Super Clip Glacé Advance	104	<b>PORTE-MINES</b>	
BIC® Super Clip Soft	106	BIC® Matic®	172
BIC® Super Clip Soft Advance	106	BIC® Matic® Ecolutions®	172
BIC® Super Clip Origin	108	BIC® Media Clic Porte-mines	174
BIC® Wide Body™	112	BIC® Media Clic Grip Porte-mines	175
BIC® Wide Body™ Ecolutions®	113	BIC® Media Clic Grip Porte-mines Ecolutions®	175
BIC® 4 Couleurs®	120		
BIC® 4 Couleurs® Rainbow Decor	122	<b>CRAYONS</b>	
BIC® 4 Couleurs® Bicolor	124	BIC® Evolution® Ecolutions®	180
BIC® 4 Couleurs® Gradient	126	BIC® Kids Evolution® Colouring Set	184
BIC® 4 Couleurs® Pastel	128	Sprout™ Graphite pencil	186
BIC® 4 Couleurs® Fashion	130		

---

## **AUTRES INSTRUMENTS D'ÉCRITURE** **188**

### **STYLOS EN PLASTIQUE**

Basic Pen	190
Click Pen	192
Striped Grip Pen	194

### **STYLOS AVEC STYLET**

Stylo Sleek Stylus	196
--------------------	-----

---

## **CARNETS** **198**

### **ROCKETBOOK®**

Rocketbook® Core Executive A5	202
Rocketbook® Fusion Executive A5	204
Rocketbook® Core Mini A6	206

### **MOLESKINE®**

Carnet de notes Moleskine® Classic	210
Moleskine® Cahier Journals	214

---

## **BRIQUETS BIC® / DJEEP® ET ÉTUIS BIC®** **216**

### **BRIQUETS**

BIC® J25 Briquet	222
BIC® J23 Briquet	226
BIC® J26 Briquet	230
BIC® J38 Briquet	234

### **AUTRES PRODUITS**

BIC® EZ Reach™	244
Cendrier de poche BIC®	248

### **ÉTUIS À BRIQUET**

BIC® Styl'it Luxury Étui	238
BIC® Aluminium Flat Étui	240
BIC® Clip Étui	241
BIC® 3D Étui	242

### **BRIQUETS DJEEP®**

Briquet DJEEP® D1	250
-------------------	-----

---

## **EMBALLAGES BIC®** **260**

Emballages BIC® Ecolutions®	262
Emballages BIC®	264

---

## **INFORMATIONS GÉNÉRALES** **268**

Commandez en toute simplicité !	270	Index des produits	277
Symboles et abréviations	274	Nuancier de couleurs	278
Informations générales	276		

# NOTRE HISTOIRE

---

**Nous sommes la division du Groupe BIC qui personnalise les produits BIC®, basée à Tarragone, en Espagne, depuis 1995.**

**Avec plus de 80 ans d'héritage de marque, nous, chez BIC Graphic, nous nous distinguons par notre engagement envers l'innovation, l'accessibilité et l'excellence. Fondés sur nos valeurs fondamentales de service client, de responsabilité sociale et de développement durable, nous sommes fiers de diriger le secteur du marketing promotionnel en Europe, au Moyen-Orient et en Afrique. Nos solutions créatives et durables aident à valoriser les marques de nos clients.**



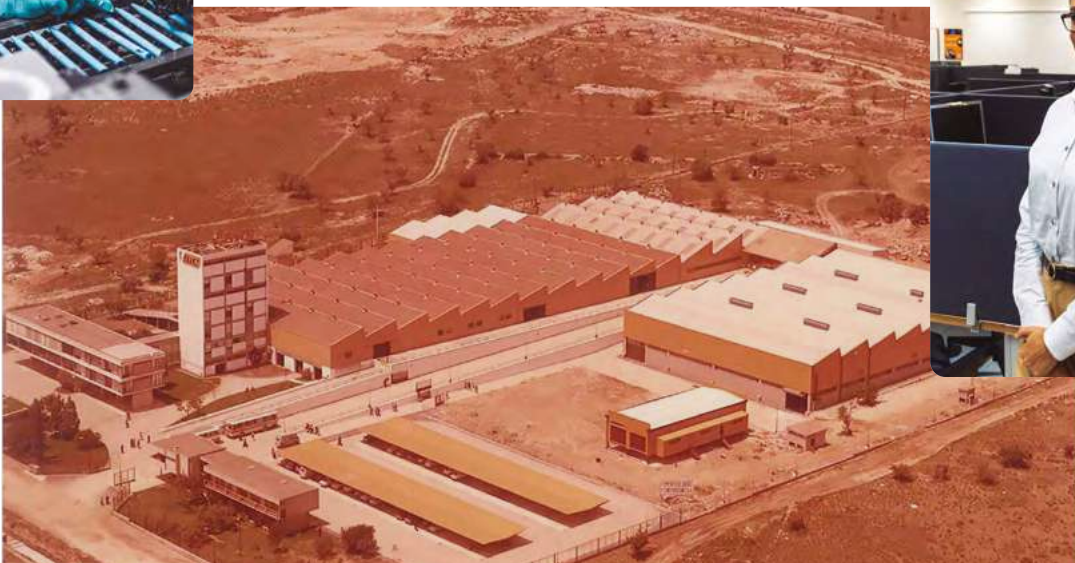

BIC GRAPHIC

INSTRUMENTS D'ÉCRITURE BIC®

AUTRES INSTRUMENTS D'ÉCRITURE

CARNETS

BRIQUETS BIC®/DIEP® ET ÉTUIS BIC®

EMBALLAGES BIC®

INFORMATIONS GÉNÉRALES

# NOS PILIERS



# Iconique et innovant

Animés par une passion pour l'innovation, nous introduisons des techniques de personnalisation de pointe, lançons des produits durables de meilleure qualité et ajoutons des finitions tendance à nos articles les plus emblématiques. En tant que marque de renommée mondiale, BIC Graphic reste un symbole de créativité tournée vers l'avenir.

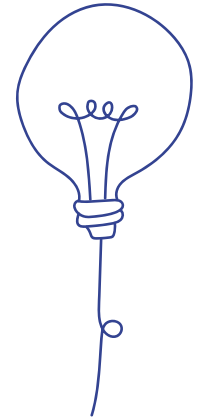

## ✓ Responsable

BIC Graphic est une référence de confiance pour les normes les plus élevées en matière de qualité et de sécurité, fermement engagée envers la responsabilité sociale, environnementale et éthique.



## Proche de vous

Nous avons toujours été à vos côtés lors des moments importants de votre vie, comprenant vos besoins comme s'ils étaient les nôtres. C'est pourquoi nous offrons une parfaite personnalisation grâce à des outils numériques, facilitant la création de ce que vous imaginez. Notre engagement en faveur de la production locale nous rapproche encore plus de vous tout en contribuant à réduire notre empreinte carbone.



# La MARQUE DES MARQUES RESPONSABLES

1

**NOUS SOMMES  
NÉS POUR ÊTRE  
UNE MARQUE  
RESPONSABLE**

Notre premier objectif est de fabriquer et de personnaliser les produits les plus utiles et les plus durables du marché, de sorte à préserver les ressources naturelles.





2

# L'INNOVATION est dans NOTRE NATURE

Tout repenser.  
Il reste encore tant de choses à découvrir.  
Ce qui a été inventé peut être réinventé.  
C'est notre approche.



# 3

# NOUS TRAVAILLONS POUR CRÉER DES SOLUTIONS SANS CRÉER DE PROBLÈMES

Nous travaillons pour apporter des solutions aux entreprises, tout en minimisant notre empreinte environnementale. À cette fin, nous utilisons exclusivement des énergies renouvelables.

En outre, nous privilégions l'utilisation de matériaux biosourcés et recyclés dans le processus de fabrication.





# 4

# NOUS SOMMES DES PERSONNES qui TRAVAILLENT AU SERVICE d'AUTRES PERSONNES

Notre manière de travailler est tout aussi importante que le résultat de nos efforts.

Nous fabriquons et personnalisons nos produits en **Europe**, en respectant les normes les plus strictes en matière de santé et de sécurité, et en œuvrant en faveur de l'égalité, de la diversité et de l'inclusion sur le lieu de travail. Nous croyons également que l'éducation est un catalyseur pour améliorer la vie des personnes.

C'est pourquoi nous nous efforçons de promouvoir l'éducation dans le monde, par le biais de la Fondation d'entreprise BIC.



# 5

# MIEUX FAIRE. en étant PLUS proches.

Nous fabriquons et personnalisons nos produits en Europe. Nous disposons de nos propres usines, ce qui nous permet de garantir des processus de travail **durables et de la plus haute qualité**. De plus, en restant proches de nos clients et de nos fournisseurs, nous sommes en mesure de réduire les délais de livraison et de **minimiser notre empreinte carbone** de manière significative. Parce que nos produits ne parcourent pas la moitié du monde pour atteindre leur destination.





# 6

# NOUS SOMMES RESPONSABLES DU DÉBUT à LA FIN

Pour nous, la responsabilité ne se limite pas à la fabrication. Nous voulons également travailler avec des fournisseurs locaux qui partagent notre respect des personnes et de la planète et qui sont prêts à assumer nos engagements. Nous assumons également une responsabilité envers nos clients, en étant conscients que notre expérience signifie notre engagement envers les personnes, l'environnement, la qualité et le service. Ce sont des aspects essentiels de notre façon de mener nos activités.



# FABRIQUÉ EN EUROPE : PROCHE DE VOUS



**“Fabriqué en Europe” est bien plus qu’un label. Depuis 1950, il est au cœur de l’engagement de BIC pour la qualité et la durabilité. De nos origines en France à nos créations personnalisées à Tarragone, en Espagne, nous concevons et produisons localement des instruments d’écriture et des briquets sélectionnés, en restant proches de vous.**

**Cette approche réduit les distances de transport et notre empreinte écologique grâce à l’approvisionnement en matériaux auprès de fournisseurs européens et à une production à la demande. Nos installations certifiées ISO 14001 et 9001 respectent les normes les plus élevées de qualité, de durabilité et de sécurité des employés.**

**Être proches de nos clients et de nos fournisseurs permet une production plus rapide, un meilleur contrôle de la chaîne d’approvisionnement et moins de retards. “Fabriqué en Europe” ne se limite pas à un lieu – c’est notre engagement envers la responsabilité, la proximité et la qualité.**





# COMMENÇONS À LA SOURCE

---

**La durabilité commence par les matériaux que nous choisissons. Certains vous surprendront peut-être, mais un véritable engagement implique de faire preuve de créativité.**

**En voici quelques exemples:**

- Fabriqué à partir de déchets de barquettes de fruits et légumes
- Fabriqué à partir de déchets pharmaceutiques
- Fabriqué à partir de déchets de pièces automobiles en plastique

**Notre gamme Ecolutions® est fabriquée à partir de matériaux durables:**

- Matériaux recyclés et recyclables
- Matériaux biosourcés
- Papier issu de forêts durables (FSC)
- Emballage en papier recyclé





FABRIQUÉ EN ESPAGNE

Fabriqué à partir de déchets de pièces automobiles.

BIC® MEDIA CLIC GRIP ECOLUTIONS®



BIC® MEDIA CLIC ECOLUTIONS®



BIC® SUPER CLIP ECOLUTIONS®



FABRIQUÉ EN ESPAGNE

Fabriqué à partir de sucre de canne.

BIC® MEDIA CLIC BIOBASED ECOLUTIONS®



Carton FSC et recyclable.

CRAYON GRAPHITE SPROUT™



FABRIQUÉ EN FRANCE

Fabriqué à partir de réfrigérateurs et de pots de yaourt.

BIC® EVOLUTION® ECOLUTIONS®



BIC® KIDS EVOLUTION® ECOLUTIONS® COLOURING SET



FABRIQUÉ EN FRANCE

Fabriqué à partir de déchets pharmaceutiques.

BIC® PERMANENT MARKER ECOLUTIONS®



BIC® MATIC® ECOLUTIONS®



FABRIQUÉ EN ESPAGNE

Fabriqué à partir de matériaux biosourcés.

BIC® SUPER CLIP ORIGIN



FABRIQUÉ EN ESPAGNE

Fabriqué à partir de déchets de plateaux de fruits et légumes.

BIC® WIDE BODY™ ECOLUTIONS®



BIC® CLIC STIC ECOLUTIONS®



BIC® ROUND STIC® ECOLUTIONS®



# Un stylo qui relie les générations



La légende dit que certaines histoires sont faites pour s'entrelacer. Le BIC® Cristal® est l'une de ces histoires, destinée à inspirer la créativité et à relier les générations. Né de la vision de Marcel Bich en 1950, ce stylo simple mais révolutionnaire a façonné des vies et éveillé la créativité à travers le monde.

Au fil des années, l'emblématique BIC® Cristal® a parcouru le monde, trouvé sa place dans votre poche, dans les trousseaux d'écoliers, sur le bureau de vos parents, et même à la caisse de votre boulangerie locale.

# Un conteur intemporel

75<sup>TH</sup>  
ANNIVERSARY OF THE BIC® CRISTAL®



Depuis 1950, le BIC® Cristal® est bien plus qu'un outil d'écriture; son design emblématique a raconté des histoires de vie, de progrès et de créativité, aidant des générations et des cultures variées à s'exprimer. Guidé par la vision de Marcel Bich de fournir un stylo abordable et de haute qualité, le BIC® Cristal® a été témoin de révolutions culturelles, de mouvements artistiques et d'innovations commerciales. Il demeure un symbole d'innovation, de précision et de connexion tout en restant fidèle à son objectif : rapprocher les gens.



# BIC® CRISTAL® EXPRESSION

Ce qui a commencé comme un simple outil d'expression est aujourd'hui devenu une expression en soi. Grâce à une technologie d'impression numérique avancée, nous avons transformé l'iconique BIC® Cristal® en une toile pour des opportunités de marque uniques. Désormais, les entreprises, les institutions culturelles et les villes peuvent personnaliser le BIC® Cristal® pour donner vie à leurs histoires et établir des connexions durables.

Jusqu'à  
**3km**  
d'écriture.



BRITEPIX™ DIGITAL  
Options en couleur intégrale  
et grandes zones d'impression.



FABRIQUÉ  
EN FRANCE 



# Brand an icon



 **BIC**  
**Cristal**  
**expression**

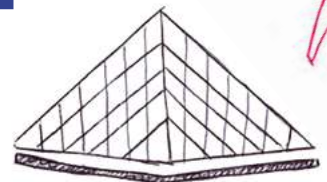

# NOUVELLES COULEURS PASTEL !

Le style ne se crée ni ne se détruit, il se transforme.  
Et c'est le cas de notre best-seller, désormais  
disponible dans de nouvelles options de couleurs qui  
lui apportent une touche spéciale et contemporaine.



FABRIQUÉ À PARTIR  
DE 69% DE MATÉRIAUX  
BIOSOURCÉS\*



FABRIQUÉ  
EN ESPAGNE



Cozy Blue



Peaceful Pink



Inspiring Autumn



BIC® KIDS EVOLUTION® COLOURING SET



# Rester toujours enfants

Un coloriage sûr et amusant pour les enfants !

Nos crayons ultra-résistants, sans bois, sont le choix idéal pour le dessin et le coloriage au quotidien. Ils sont très faciles à tailler, ils ne font pas d'écharde en cas de brisure, et sûrs à utiliser—même s'ils sont mâchouillés !

Le compagnon idéal pour la créativité de vos petits artistes !



FABRIQUÉ À PARTIR DE 51% DE MATÉRIAUX BIOSOURCÉS\*



RÉFRIGÉRATEURS ET POTS DE YAOURT



UTILISATION SÛRE POUR LES ENFANTS





# NOUVEAU



INFORMATIONS GÉNÉRALES

EMBALLAGES BIC®

BRIQUETS BIC®/DIEEP® ET ÉTUIS BIC®

CARNETS

AUTRES INSTRUMENTS D'ÉCRITURE

INSTRUMENTS D'ÉCRITURE BIC®

BIC GRAPHIC





**BIC® EZ REACH™**

# ILLUMINEZ VOS MOMENTS UNIQUES



Les occasions avec une flamme sûre sont infinies avec le nouveau **BIC® EZ Reach™**



**Les moments les plus incroyables commencent lorsque quelqu'un allume la flamme.**



## **Flamme sûre**

- Aide à garder les doigts éloignés de la flamme.



NOUVEAU !



# Un ensemble de produits BIC® dans des boîtes personnalisables

Vous pouvez aller encore plus loin dans la personnalisation avec notre boîte en carton FSC, personnalisable sur chaque face. Idéal pour proposer nos produits iconiques BIC® à travers une collection. Plus qu'un emballage, un excellent moyen d'optimiser vos ventes.



CARTON FSC  
ET RECYCLABLE



FABRIQUÉ  
EN EUROPE

**100%**  
***Personnalisable !***

EMBALLAGE SPÉCIAL POUR :

**BIC® Cristal® Expression**  
**BIC® Round Stic®**  
**BIC® Style**  
**BIC® Clic Stic**

BIC® COLLECTION  
BOX SLIM PENS  
4 UNITÉS  
529294



NOUVEAU !

BIC  
GRAPHIC

INSTRUMENTS  
D'ÉCRITURE BIC®

AUTRES INSTRUMENTS  
D'ÉCRITURE

CARNETS

BRIQUETS BIC®/DIEEP®  
ET ÉTUIS BIC®

EMBALLAGES  
BIC®

INFORMATIONS  
GÉNÉRALES

EMBALLAGE SPÉCIAL POUR :

**BIC® 4 Couleurs®**  
**BIC® Wide Body™**  
**BIC® Super Clip**  
**BIC® Brite Liner® Grip**  
**BIC® Grip Roller**

BIC® COLLECTION BOX  
1 UNITÉ  
991212

BIC® COLLECTION BOX  
2 UNITÉS  
991213

BIC® COLLECTION BOX  
3 UNITÉS  
991214



# Nos techniques d'impression

---

**Notre processus de personnalisation des produits est soumis à des contrôles de qualité stricts, est conforme à toutes les réglementations de l'UE et passe 5 tests de qualité différents :**

- Test d'adhésion
- Test de résistance aux rayures (ISO 12137:11)
- Test d'abrasion
- Test de résistance
- Test d'exposition à la transpiration par simulation

## **Tests de contrôle de qualité**

Chaque commande de produits imprimés passe 4 contrôles de qualité distincts :

- Contrôle de l'apparence esthétique
- Contrôle de la couleur imprimée
- Contrôle de l'adhérence de l'impression
- Résistance aux rayures





Avec comme garantie nos plus de 50 ans d'expérience !



SP

### Screen printing

Une technique parfaite pour créer des impressions de qualité et les correspondances de couleurs.



BR

### Brilliant

Choisissez la finition brillante pour un effet final éblouissant.



MT

### Matt

La finition mate permet d'ajouter une touche d'élégance à votre design.



M

### Metallic

Créez de superbes effets ! Effets métalliques sur les textes, les images et le fond.

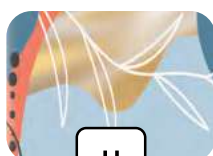

H

### Holographic

Démarquez-vous de la concurrence ! Jouez avec les reflets dorés ou argentés dans votre design.



P

### Puffy

Personnalisation mise en évidence qui donne un effet de relief à votre logo.



PG

### Puffy Glitter

Embellissez vos designs avec l'effet scintillant des paillettes. Voyez et sentez sa texture pailletée et colorée.

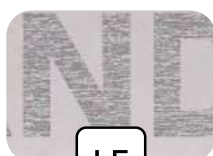

LE

### Laser

La gravure au laser vous permettra de donner un effet élégant à vos communications. Utilisez-la et obtenez une impression durable.



UV

### UV

Faites ressortir votre marque avec une finition très brillante ! Associez une finition mate et une finition brillante pour souligner les contrastes.



BP

### BritePix™ Digital

La solution pour une communication tout en couleur. Maintenant sur des corps en couleur !



BP

### BritePix™ Texture

BritePix™ Texture apporte une nouvelle touche haut de gamme au concept britePix™. Désormais, vous pouvez non seulement voir tout en couleur, mais aussi le toucher !



BP

### BritePix™ Personalisation

BritePix™ personalisation. Personnalisez chaque unité dans une seule et même commande britePix™.



Impression  
360°



Tout en  
couleur



Qualité  
photographique

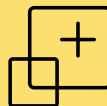

Haute  
définition



Couleurs illimitées  
et améliorées

# Votre solution la plus Colorée

---



## **britePix™ DIGITAL**

La solution pour une communication tout en couleur avec une excellence photographique, une technique d'impression durable, pour que votre logo reste gravé dans les mémoires. Maintenant sur des corps en couleur !



## **britePix™ TEXTURE**

BritePix™ Texture apporte une nouvelle touche haut de gamme au concept britePix™. Désormais, vous pouvez non seulement voir tout en couleur, mais aussi le toucher !



## **britePix™ PERSONALISATION**

Personnalisez chaque unité dans une seule et même commande britePix™.

# britepix™



BIC® Evolution® Ecolutions®



BIC® Super Clip Advance



BIC® Round Stic®



BIC® Clic Stic



BIC® Wide Body™



BIC® 4 Couleurs®



BIC® Media Clic



BIC® XS Finestyle

Index

# INSTRUMENTS D'ÉCRITURE

# BIC®

---

# 01



## STYLOS

BIC® Cristal® Expression	40
BIC® Cristal® Re'New™	44
BIC® Style	48
BIC® Round Stic®	52
BIC® Round Stic® BGuard™ antibactérien	54
BIC® Round Stic® Ecolutions®	55
BIC® M10® Clic	58
BIC® Media Clic	62
BIC® Media Clic Ecolutions®	63
BIC® Media Clic Grip	65
BIC® Media Clic Grip Ecolutions®	66
BIC® Media Clic BGuard™ antibactérien	72
BIC® Media Clic BGuard™ antimicrobial Ecolutions®	74
BIC® Media Clic Biobased Ecolutions®	78
BIC® Media Clic Biobased BGuard™ antibactérien	80
BIC® Media Clic Shine	82
BIC® Media Clic Glacé	84
BIC® Clic Stic	86
BIC® Clic Stic Ecolutions®	87
BIC® Clic Stic Stylus	90
BIC® Clic Stic Stylus Ecolutions®	90
BIC® Super Clip	96
BIC® Super Clip Ecolutions®	97
BIC® Super Clip Advance	100
BIC® Super Clip Glacé	104
BIC® Super Clip Glacé Advance	104
BIC® Super Clip Soft	106
BIC® Super Clip Soft Advance	106
BIC® Super Clip Origin	108
BIC® Wide Body™	112
BIC® Wide Body™ Ecolutions®	113
BIC® 4 Couleurs®	120
BIC® 4 Couleurs® Rainbow Decor	122
BIC® 4 Couleurs® Bicolor	124
BIC® 4 Couleurs® Gradient	126
BIC® 4 Couleurs® Pastel	128
BIC® 4 Couleurs® Fashion	130
BIC® 4 Couleurs® Sun	132
BIC® 4 Couleurs® Fine	134

BIC® 4 Couleurs® Fluo	136
BIC® 4 Couleurs® Glacé	138
BIC® 4 Couleurs® Shine	140
BIC® 4 Couleurs® Soft	142
BIC® 4 Couleurs® Wood Style	144
BIC® 4 Couleurs® Flags Collection	146
BIC® 4 Couleurs® 3+1 <sup>HB</sup>	148

## STYLOS EN MÉTAL

BIC® Metal Pro	150
----------------	-----

## ROLLERS ET GELS

BIC® Grip Roller	156
BIC® XS Finestyle	158
BIC® Intensity® Gel Clic	160

## SURLIGNEURS ET MARQUEURS

BIC® Brite Liner® Grip	164
BIC® Velleda® White Board Marker Fine	166
BIC® Velleda® White Board Marker Grip	167
BIC® Mark-It Permanent Marker	168
BIC® Permanent Marker Ecolutions®	169

## PORTE-MINES

BIC® Matic®	172
BIC® Matic® Ecolutions®	172
BIC® Media Clic Porte-mines	174
BIC® Media Clic Grip Porte-mines	175
BIC® Media Clic Grip Porte-mines Ecolutions®	175

## CRAYONS

BIC® Evolution® Ecolutions®	180
BIC® Kids Evolution® Colouring Set	184
Sprout™ Graphite pencil	186

# BIC® CRISTAL® EXPRESSION

## Brand an Icon.

Découvrez l'évolution du célèbre BIC® Cristal® avec le BIC® Cristal® Expression. Ce stylo classique allie désormais un design intemporel à la technologie d'impression numérique de pointe BritePix™ Digital, offrant ainsi une personnalisation unique.





**BIC® CRISTAL® EXPRESSION**

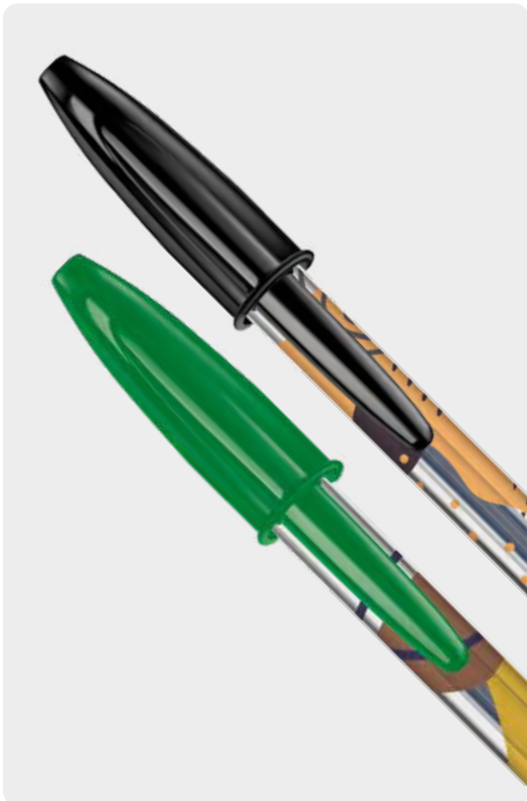
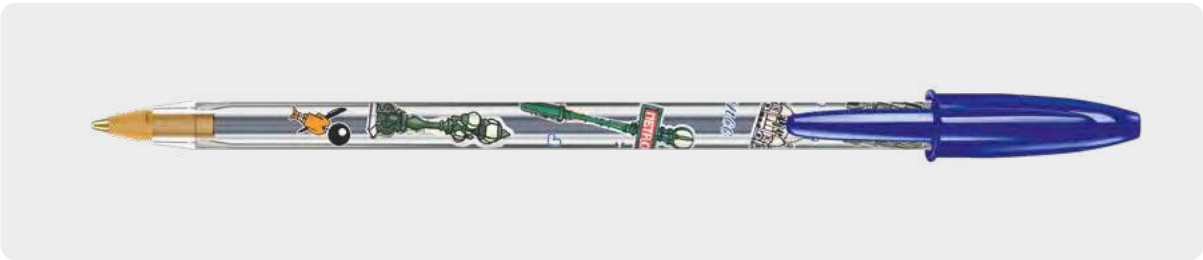

# Objet emblématique du design

1095

BIC® CRISTAL®  
EXPRESSION

1095

Couleur d'encre



NOUVEAU !



02



03



05



100%

04



## Personnalisation

1095

**BIC® CRISTAL® EXPRESSION**

1095

A BP: BritePix™ Digital

MOQ 250 u.

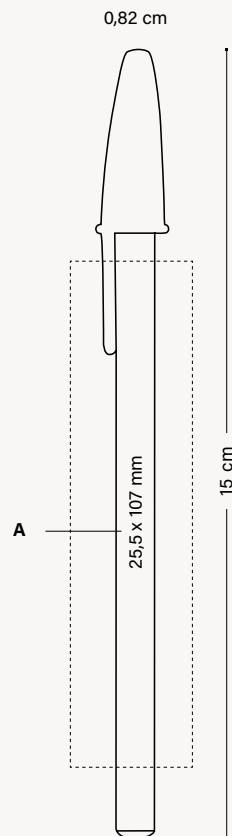

### EMBALLAGE SPÉCIAL EN OPTION



BIC COLLECTION  
BOX SLIM PENS

**Nouveau !**

+ INFO PAGES 262 À 266

### EMBALLAGE EXTERNE



500 ± 3,5 KG



MODES  
D'ÉCRITURE



TECHNIQUES  
D'IMPRESSION



BRITEPIX™ DIGITAL

DURABILITÉ



LE PARTENARIAT  
TERRACYCLE® PERMET  
DE RECYCLER  
LES INSTRUMENTS  
D'ÉCRITURE BIC EN FRANCE

BIC  
GRAPHIC

INSTRUMENTS  
D'ÉCRITURE BIC®

AUTRES INSTRUMENTS  
D'ÉCRITURE

CARNETS

BRIQUETS BIC®/DIEEP®  
ET ÉTUIS BIC®

EMBALLAGES  
BIC®

INFORMATIONS  
GÉNÉRALES

Consultez les pages 274-277 pour une explication détaillée des icônes

# BIC® CRISTAL® RE'NEW™



## L'iconique BIC® Cristal® version métallique.

Le nouveau BIC® Cristal® Re'New™ reprend le design de l'iconique BIC® Cristal® Original et ajoute une touche de modernité grâce à son corps au rendu aluminium mat et l'inscription au laser du logo BIC®. Le capuchon a été également redessiné: il est gris mat et fabriqué à partir de plastique recyclé à 96%. Rechargeable à encre bleue ou noire avec 2 recharges incluses.

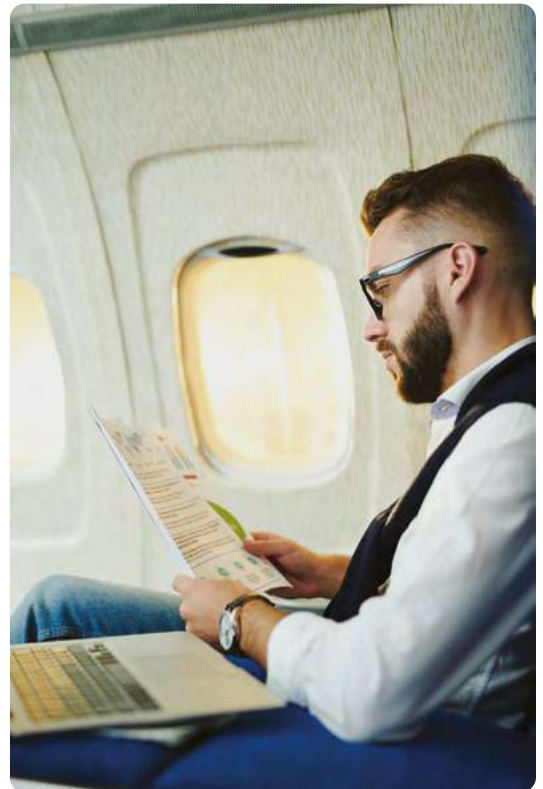

**BIC® CRISTAL® RE'NEW™**



# L'élégance revêtu de métal.

1090

BIC® CRISTAL®  
RE'NEW™

1090

Couleur d'encre



BIC® WINDOW BOX

1 STYLO + 2 CARTOUCHES



*Votre Cristal® Re'New™ avec  
toujours le même coffret-cadeau !*

(Inclus dans le prix)



1090

**BIC® CRISTAL® RE'NEW™**

1090

A LE: max. 1 col.

Commande minimale 25 u.

Personnalisation

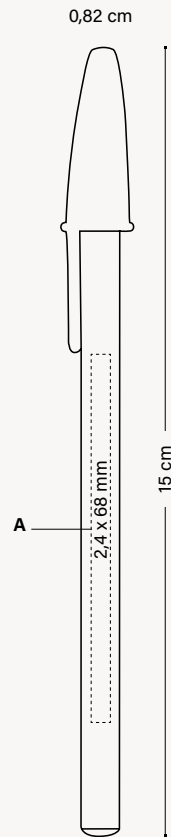

EMBALLAGE EXTERNE



MODES D'ÉCRITURE



TECHNIQUES D'IMPRESSION



DURABILITÉ



LE PARTENARIAT TERRACYCLE® PERMET DE RÉCYCLER LES INSTRUMENTS D'ÉCRITURE BIC EN FRANCE

BIC GRAPHIC

INSTRUMENTS D'ÉCRITURE BIC®

AUTRES INSTRUMENTS D'ÉCRITURE

CARNETS

BRIQUETS BIC®/DIEEP® ET ÉTUIS BIC®

EMBALLAGES BIC®

INFORMATIONS GÉNÉRALES

Consultez les pages 274-277 pour une explication détaillée des icônes.

---

BIC® STYLE

**Facilement  
reconnaissable dans  
le monde entier grâce  
à son capuchon  
emblématique.**

Le BIC® Style offre un excellent  
rapport qualité-prix.



1610

**BIC® STYLE**  
1610 Opaque

Couleur d'encre



01/01



01/03



01/04



01/02

●  
Disponible avec  
encre noire  
uniquement



02/02



04

●  
Disponible avec  
encre bleue  
uniquement



10

●  
Disponible avec  
encre noire  
uniquement

100%



MODES  
D'ÉCRITURE



STYLO M  
0.1 MM

TECHNIQUES  
D'IMPRESSION



SÉRIGRAPHIE

DURABILITÉ



IMPRIM'VERT®



100 % DE L'ÉLECTRICITÉ  
PROVIENT DE SOURCES  
RENOUVELABLES



LE PARTENARIAT  
TERRACYLE® PERMET  
DE RÉCYCLER  
LES INSTRUMENTS  
D'ÉCRITURE BIC EN FRANCE

Consultez les pages 274-277 pour une explication détaillée des icônes.

1610

---

**BIC® STYLE**  
1610 Transparent

Couleur d'encre



92

87

88

89

8H

93

100%



Personnalisation

1610

**BIC® STYLE**

1610 Opaque  
**A SP:** max. 1 col.

**BIC® STYLE**

1610 Transparent  
**B SP:** max. 1 col.

Commande minimale 500 u.

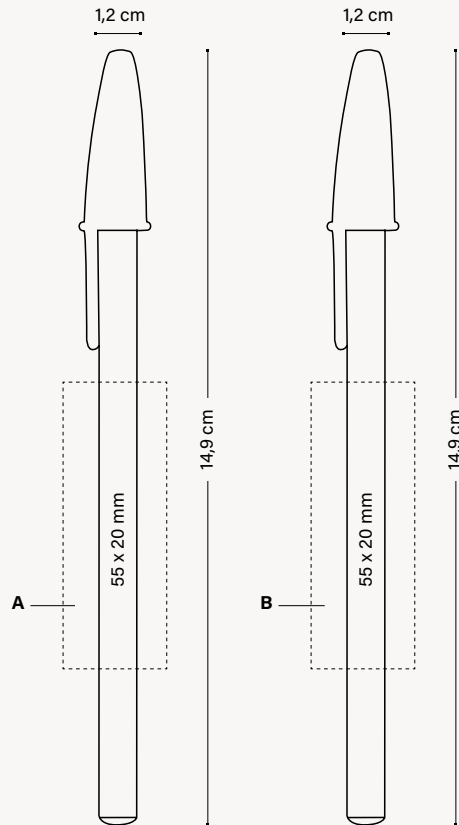

MODES D'ÉCRITURE



TECHNIQUES D'IMPRESSION



DURABILITÉ



100 % DE L'ÉLECTRICITÉ PROVIENT DE SOURCES RENOUVELABLES



LE PARTENARIAT TERRACYLE® PERMET DE RÉCYCLER LES INSTRUMENTS D'ÉCRITURE BIC EN FRANCE

EMBALLAGE SPÉCIAL EN OPTION



BIC COLLECTION BOX SLIM PENS

**Nouveau !**

+ INFO PAGES 262 À 266

EMBALLAGE EXTERNE



500 ± 3,5 KG

Peut être utilisé comme marque-page

Consultez les pages 274-277 pour une explication détaillée des icônes.

BIC GRAPHIC

INSTRUMENTS D'ÉCRITURE BIC®

AUTRES INSTRUMENTS D'ÉCRITURE

CARNETS

BRIQUETS BIC®/DIEEP® ET ÉTUIS BIC®

EMBALLAGES BIC®

INFORMATIONS GÉNÉRALES

---

BIC® ROUND STIC®

**L'iconique BIC® Round Stic®  
offre un style indémodable  
et une très grande qualité.**

Son design classique est facile  
à identifier et il est synonyme  
de fiabilité à long terme.



1010

**BIC® ROUND STIC®**  
1010 Opaque

Couleur d'encre  
● ● ●

Encre rouge disponible sur demande



l'icône BIC® Boy et  
le logo BIC® en relief !



12



05



07



18



02



03



100%

impression  
360°

Disponible en  
corps blanc



**MIX &  
MATCH**



COULEURS  
PERSONNALISÉES



FABRIQUÉ ET  
IMPRIMÉ DANS  
LES USINES BIC



FABRIQUÉ EN  
ESPAGNE



RESPECTANT  
LES NORMES



ISO  
certifié

MODES  
D'ÉCRITURE



STYLO M  
Ø 1 MM

TECHNIQUES  
D'IMPRESSION



SP  
SÉRIGRAPHIE



DG  
DIGITAL

DURABILITÉ



IMPRIM'VERT®



100 % DE L'ÉLECTRICITÉ  
PROVIENT DE SOURCES  
RENOUVELABLES



LE PARTENARIAT  
TERRACYLE® PERMET  
DE RÉCYCLER  
LES INSTRUMENTS  
D'ÉCRITURE BIC EN FRANCE

BIC  
GRAPHIC

INSTRUMENTS  
D'ÉCRITURE BIC®

AUTRES INSTRUMENTS  
D'ÉCRITURE

CARNETS

BRIQUETS BIC®/DIEEP®  
ET ÉTUIS BIC®

EMBALLAGES  
BIC®

INFORMATIONS  
GÉNÉRALES

Consultez les pages 274-277 pour une explication détaillée des icônes.



1010

**BIC® ROUND STIC®**  
1010 Givré

Couleur d'encre



*Encre rouge disponible sur demande*



69      63      71      66      67      40      68

1011

**BIC® ROUND STIC® BGUARD**  
**ANTIBACTÉRIEN**

1011 Opaque

Couleur d'encre



*Encre rouge disponible sur demande*

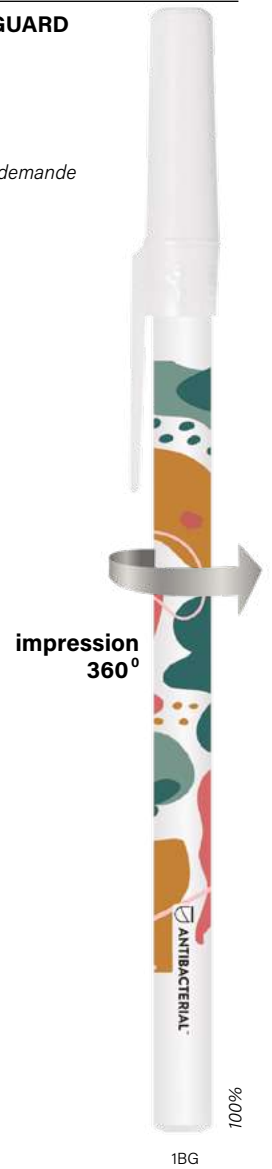

1BG

*Disponible en  
corps blanc*





Version ECO.  
Comme Standard aux mêmes prix !

**ecolutions®**



FABRIQUÉ À PARTIR DE 98%  
DE MATÉRIEL RECYCLÉ\*

\*Hors système d'encre

CAGEOTS  
DE FRUITS  
ET LÉGUMES



1E10

**BIC® ROUND STIC®**  
1E10 Opaque

Couleur d'encre



Encre rouge disponible  
sur demande



1E/8E

1E/7E

1E/3E



impression  
360°

100%

Disponible en  
corps blanc



1E10

**BIC® ROUND STIC®**  
1E10 Givré

Couleur d'encre



Encre rouge disponible  
sur demande



2E/8E

2E/7E

2E/3E

2E/10E

100%

**MIX &  
MATCH**



COULEURS  
PERSONNALISÉES



FABRIQUÉ ET  
IMPRIMÉ DANS  
LES USINES BIC



FABRIQUÉ EN  
ESPAGNE



RESPECTANT  
LES NORMES



MODES  
D'ÉCRITURE



STYLO M  
Ø 1 MM

TECHNIQUES  
D'IMPRESSION



SÉRIGRAPHIE



DIGITAL

DURABILITÉ



**ecolutions®**



CAGEOTS  
DE FRUITS  
ET LÉGUMES



100 % DE L'ÉLECTRICITÉ  
PROVIENT DE SOURCES  
RENOUVELABLES



LE PARTENARIAT  
TERRACYCLE® PERMET  
DE RECYCLER  
LES INSTRUMENTS  
D'ÉCRITURE BIC EN FRANCE

BIC  
GRAPHIC

INSTRUMENTS  
D'ÉCRITURE BIC®

AUTRES INSTRUMENTS  
D'ÉCRITURE

CARNETS

BRIQUETS BIC®/DIEEP®  
ET ÉTUIS BIC®

EMBALLAGES  
BIC®

INFORMATIONS  
GÉNÉRALES

\*Pourcentage calculé sur le poids total du produit cartouche exclue. En raison du contenu recyclé des matières premières avec lesquelles le produit est fabriqué, nous ne pouvons pas garantir que les couleurs qui apparaissent dans le catalogue, ni les couleurs personnalisées à la carte, aient toujours la même couleur et la même apparence.

1010 / 1E10 / 1011

## BIC® ROUND STIC®

1010 / **ecolutions®** 1E10 Opaque

1010 / **ecolutions®** 1E10 Givré

1011/ BGuard™ Antibactérien

Commande minimale 500 u.

Combinaison de couleurs standards

**MIX & MATCH**

Sans frais supplémentaires

BGuard™

**ecolutions®**



CAGEOTS DE FRUITS ET LÉGUMES

Combinaison de couleurs standards\*

## Bouton

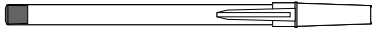

Opaque



Givré

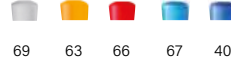

Antibactérien

1BG



## Capuchon

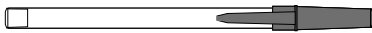

Opaque

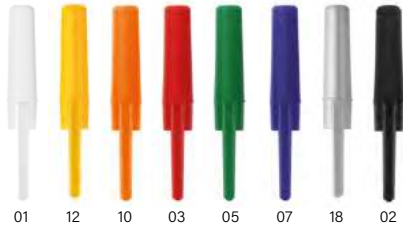

Givré



Antibactérien

1BG



## Section

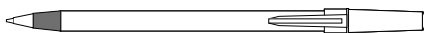

Opaque

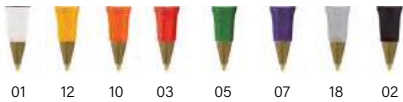

Givré

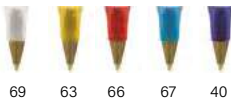

Antibactérien

1BG



## Corps



Opaque

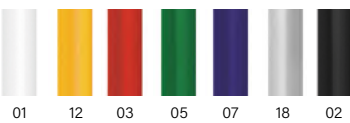

Givré

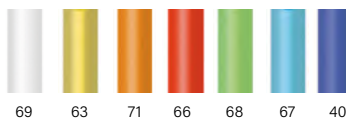

Antibactérien

1BG

Opaque Givré

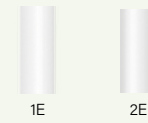

Injection d'une couleur spéciale: ≥ 10.000 unités



\*\*Hors système d'encrage.

Ajoutez la boucle mobius sur votre BAT sans frais additionnels. Merci de le préciser dans votre bon de commande (en bas à gauche par défaut)

\*En raison du contenu recyclé des matières premières avec lesquelles le produit est fabriqué, nous ne pouvons pas garantir que les couleurs qui apparaissent dans le catalogue, ni les couleurs personnalisées à la carte, aient toujours la même couleur et la même apparence.

\*\* Le pourcentage est calculé sur la base du poids total du porte-mine, à l'exclusion du système de la mine.

1010 / 1E10

**BIC® ROUND STIC®**

1010

ecolutions® 1E10

A SP: max. 3 col.

B SP: max. 1 col.

C SP: max. 1 col.

D DG: Numérique

(uniquement disponible en corps blanc)

Commande minimale 500 u.

1011

**BIC® ROUND STIC®  
BGUARD™ ANTIBACTÉRIEN**

1011

A SP: max. 2 col.

D DG: Numérique

(uniquement disponible en corps blanc)

Commande minimale 500 u.

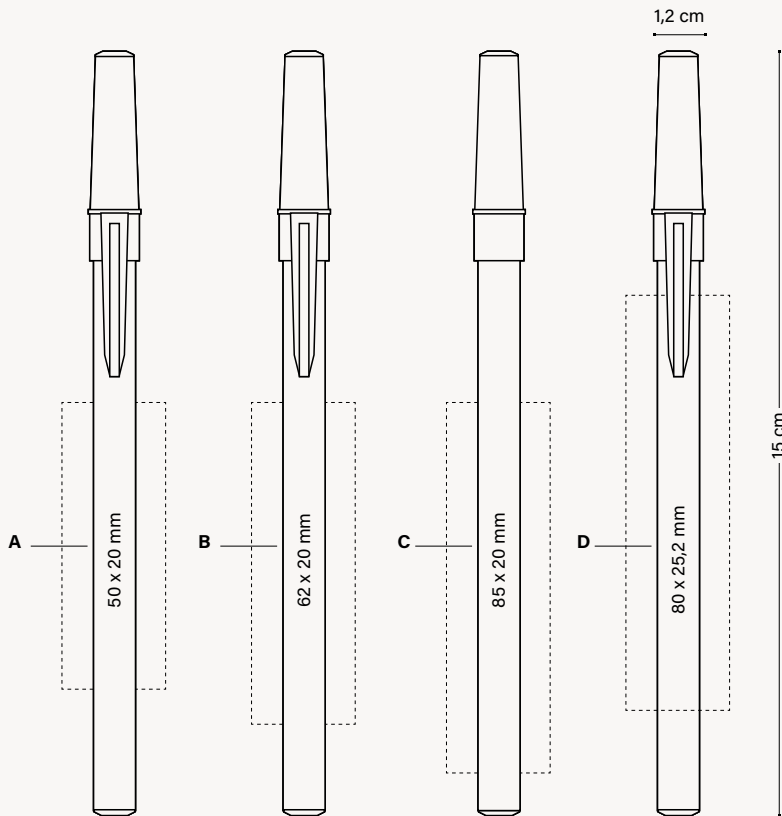

EMBALLAGE SPÉCIAL EN OPTION



PLASTIC  
POUCH



BIC COLLECTION  
BOX SLIM PENS

*Nouveau !*

+ INFO PAGES 262 À 266

Peut être  
utilisé comme  
marque-page

EMBALLAGE EXTERNE



500 ± 2,5 KG



MODES  
D'ÉCRITURE



TECHNIQUES  
D'IMPRESSION



DURABILITÉ



ecolutions®



100 % DE L'ÉLECTRICITÉ  
PROVIENT DE SOURCES  
RENOUVELABLES



LE PARTENARIAT  
TERRACYCLE® PERMET  
DE RECYCLER  
LES INSTRUMENTS  
D'ÉCRITURE BIC EN FRANCE



l'icône  
BIC® Boy et  
le logo BIC®  
en relief !

1590

BIC® M10® CLIC  
1590

Couleur d'encre



01

8G

10

14

59

04

02

3D

100%

●  
Disponible avec  
encre noire  
uniquement



## Personnalisation

1590

**BIC® M10® CLIC**

1590

A SP: max. 2 col.

Commande minimale 500 u.

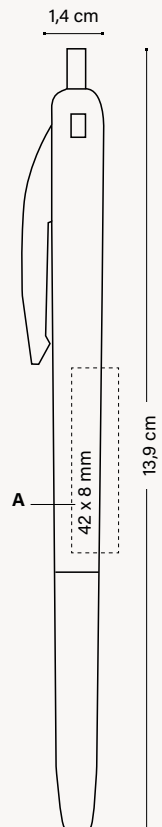

### EMBALLAGE SPÉCIAL EN OPTION



PLASTIC  
POUCH



WINDOW  
BOX

+ INFO PAGES 262 À 266

*Peut être  
utilisé comme  
marque-page*

### EMBALLAGE EXTERNE



500 ± 4,1 KG



FABRIQUÉ ET  
IMPRIMÉ DANS  
LES USINES BIC



FABRIQUÉ  
EN FRANCE



LE MODÈLE BLANC  
EST FABRIQUÉ  
EN AFRIQUE DU SUD



RESPECTANT  
LES NORMES



MODES  
D'ÉCRITURE



STYLO M  
Ø 1 MM

TECHNIQUES  
D'IMPRESSION



SÉRIGRAPHIE

DURABILITÉ



100 % DE L'ÉLECTRICITÉ  
PROVIENT DE SOURCES  
RENOUVELABLES



LE PARTENARIAT  
TERRACYCLE® PERMET  
DE RECYCLER  
LES INSTRUMENTS  
D'ÉCRITURE BIC EN FRANCE



REGARDEZ LA VIDEO

Consultez les pages 274-277 pour une explication détaillée des icônes.



Notre BIC® Media Clic, un best-seller de l'industrie, au design fonctionnel et largement reconnu, est un produit durable disponible dans différents matériaux. Choisissez parmi le Standard, Recyclé, Biobased, Antibactérien et finitions premium.

Laissez-vous inspirer par la vaste gamme de finitions et de couleurs, et associez-les pour mettre en valeur votre marque.

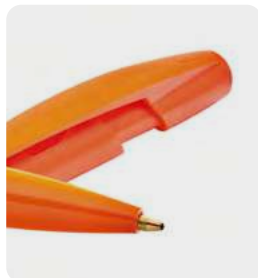

**ECOLUTIONS®**  
**GRIP**  
**GRIP ECOLUTIONS®**  
**BGUARD™ ANTIBACTÉRIEN**  
**BGUARD™ ANTIMICROBIAL**  
**BIOBASED**  
**BIOBASED BGUARD™ ANTIBACTÉRIEN**  
**SHINE**  
**GLACÉ**

1025



Iconique  
BIC® Boy  
en relief!



Disponible  
aussi en version  
porte-mines

## BIC® MEDIA CLIC

1025 Stylo / 1028 Porte-mines (consultez la page 174)

Opaque

Couleur d'encre



Encre rouge disponible sur demande







Version ECO.  
Comme Standard aux mêmes prix !

**ecolutions®**

**98%** FABRIQUÉ À PARTIR DE **98% DE MATÉRIEL RECYCLÉ\***  
\*Hors système d'encre

PIÈCES AUTOMOBILES EN PLASTIQUE

**1E25**

**BIC® MEDIA CLIC**  
1E25 Stylo  
Opaque  
Couleur d'encre  
● ● ●

**MIX & MATCH**

 COULEURS PERSONNALISÉES

 FABRIQUÉ ET IMPRIMÉ DANS LES USINES BIC

 FABRIQUÉ EN ESPAGNE

 RESPECTANT LES NORMES

 ISO certified

**MODES D'ÉCRITURE**

 STYLO M Ø 1 MM

**TECHNIQUES D'IMPRESSION**

 SP  
SÉRIGRAPHIE

 DG  
DIGITAL

**DURABILITÉ**

 **IMPRIM'VERT®**

**ecolutions®**

 PIÈCES AUTOMOBILES EN PLASTIQUE

 100 % DE L'ÉLECTRICITÉ PROVIENT DE SOURCES RENOUVELABLES

 LE PARTENARIAT TERRACYCLE® PERMET DE RECYCLER LES INSTRUMENTS D'ÉCRITURE BIC EN FRANCE

BIC GRAPHIC

INSTRUMENTS D'ÉCRITURE BIC®

AUTRES INSTRUMENTS D'ÉCRITURE

CARNETS

BRIQUETS BIC®/DIEEP® ET ÉTUIS BIC®

EMBALLAGES BIC®

INFORMATIONS GÉNÉRALES

\*Pourcentage calculé sur le poids total du produit cartouche exclue. En raison du contenu recyclé des matières premières avec lesquelles le produit est fabriqué, nous ne pouvons pas garantir que les couleurs qui apparaissent dans le catalogue, ni les couleurs personnalisées à la carte, aient toujours la même couleur et la même apparence.

Consultez les pages 274-277 pour une explication détaillée des icônes.

1025

 Disponible  
aussi en version  
porte-mines

## BIC® MEDIA CLIC

1025 Stylo / 1028 Porte-mines (consultez la page 174)

Givré

Couleur d'encre



Encre rouge disponible sur demande



1020 / 1021

**BIC® MEDIA CLIC GRIP**

1020 Stylo

1021 Porte-mines (consultez la page 175)

Givré

Couleur d'encre



Disponible  
aussi en version  
porte-mines



01/69



71/69



82/69



40/69

100%

MIX &  
MATCH



COULEURS  
PERSONNALISÉES



FABRIQUÉ ET  
IMPRIMÉ DANS  
LES USINES BIC



FABRIQUÉ EN  
ESPAGNE



RESPECTANT  
LES NORMES



MODES  
D'ÉCRITURE



STYLO M  
Ø 1 MM

TECHNIQUES  
D'IMPRESSION



SÉRIGRAPHIE



DIGITAL

DURABILITÉ



100 % DE L'ÉLECTRICITÉ  
PROVIENT DE SOURCES  
RENOUVELABLES



LE PARTENARIAT  
TERRACYCLE® PERMET  
DE RECYCLER  
LES INSTRUMENTS  
D'ÉCRITURE BIC EN FRANCE

Consultez les pages 274-277 pour une explication détaillée des icônes.

**MIX & MATCH**



COULEURS PERSONNALISÉES



FABRIQUÉ ET IMPRIMÉ DANS LES USINES BIC



FABRIQUÉ EN ESPAGNE



RESPECTANT LES NORMES



**MODES D'ÉCRITURE**



STYLO M  
Ø 1 MM

**TECHNIQUES D'IMPRESSION**



SÉRIGRAPHIE



DIGITAL

**DURABILITÉ**



IMPRIM'VERT®

**ecolutions®**



PIÈCES AUTOMOBILES EN PLASTIQUE



100 % DE L'ÉLECTRICITÉ PROVIENT DE SOURCES RENOUVELABLES



LE PARTENARIAT TERRACYCLE® PERMET DE RECYCLER LES INSTRUMENTS D'ÉCRITURE BIC EN FRANCE



Disponible aussi en version porte-mines

Version ECO. Comme Standard aux mêmes prix !

**ecolutions®**



FABRIQUÉ À PARTIR DE 98% DE MATÉRIEL RECYCLÉ\*

\*Hors système d'encre



PIÈCES AUTOMOBILES EN PLASTIQUE

1E20 / 1E21

**BIC® MEDIA CLIC GRIP**

1E20 Stylo  
1E21 Porte-mines (consultez la page 175)  
Opaque

Couleur d'encre



01/03



01/05



01/02



01/07

100%



**MIX & MATCH** Sans frais supplémentaires

Commande minimale 500 u.  
ecolutions® Combinaison de couleurs standards

**Bouton**

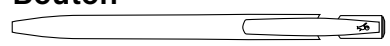

- Opaque 01 12 10 03 5C 2D 13 5G 05 3D 04 07 18 02 Givré 69

**Clip**

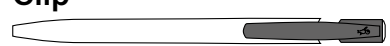

- 01 12 10 03 5C 2D 13 5G 05 3D 04 07 18 02 Opaque 69

**Corps**



- Opaque 01 12 10 03 5C 2D 13 5G 05 3D 04 07 3C 18 02  
Givré 69 63 71 66 68 82 67 40 4B

**Corps et Grip**

- 01/69 71/69 82/69 40/69

Injection d'une couleur spéciale: > 10.000 unités 1025/1E25  
Injection d'une couleur spéciale: > 20.000 unités 1020/1E20



**ecolutions®**  
PIÈCES AUTOMOBILES EN PLASTIQUE

Combinaison de couleurs standards\*

Opaque 1E 3E

Corps et Grip Opaque 01/03 01/05 01/07 01/02

98% Recycled

\*Hors système d'encre  
Ajoutez la boucle mobius sur votre BAT sans frais additionnels. Merci de le préciser dans votre bon de commande (en bas à gauche par défaut)



- COULEURS PERSONNALISÉES
- FABRIQUÉ ET IMPRIMÉ DANS LES USINES BIC

- TECHNIQUES D'IMPRESSION
- SP SÉRIGRAPHIE
- DG DIGITAL

- MODES D'ÉCRITURE
- STYLO M Ø 1 MM

- DURABILITÉ
- PIÈCES AUTOMOBILES EN PLASTIQUE
- LE PARTENARIAT TERRACYCLE® PERMET DE RECYCLER LES INSTRUMENTS D'ÉCRITURE BIC EN FRANCE

\*En raison du contenu recyclé des matières premières avec lesquelles le produit est fabriqué, nous ne pouvons pas garantir que les couleurs qui apparaissent dans le catalogue, ni les couleurs personnalisées à la carte, aient toujours la même couleur et la même apparence.

Consultez les pages 274-277 pour une explication détaillée des icônes.

1025 / 1028 / 1E25

**BIC® MEDIA CLIC**

1025 Stylo

1028 Porte-mines (*consultez la page 174*)

ecolutions® 1E25 Stylo

**A SP:** max. 4 col.

**B SP:** max. 2 col.

**C DG:** numérique

Commande minimale 500 u.

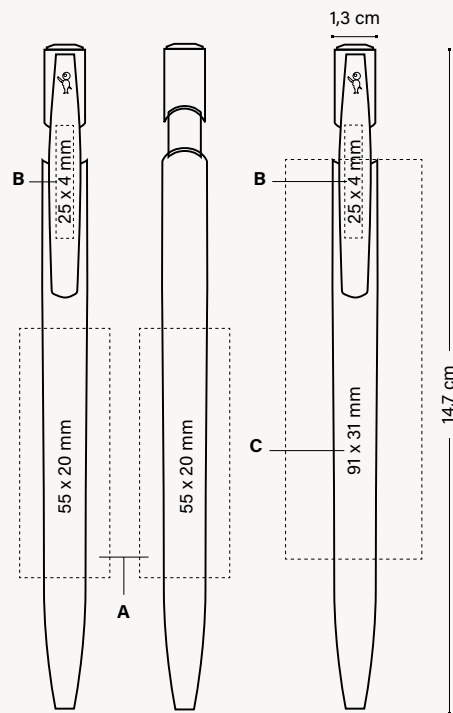

**EMBALLAGE SPÉCIAL EN OPTION**

**EMBALLAGE EXTERNE**



ECO SLEEVE

+ INFO PAGES 262 À 266



PLASTIC POUCH



WINDOW BOX



500 ± 4,1 KG

*Peut être utilisé comme marque-page*



FABRIQUÉ ET IMPRIMÉ DANS LES USINES BIC



FABRIQUÉ EN ESPAGNE



SP SÉRIGRAPHIE



DG DIGITAL

**MODES D'ÉCRITURE**



STYLO M Ø 1 MM

**DURABILITÉ**



PIÈCES AUTOMOBILES EN PLASTIQUE



LE PARTENARIAT TERRACYCLE® PERMET DE RECYCLER LES INSTRUMENTS D'ÉCRITURE BIC EN FRANCE

1020 / 1E20 / 1021 / 1E21

**BIC® MEDIA CLIC GRIP**

1020 Stylo  
1021 Porte-mines  
(consultez la page 175)

**D SP:** max. 4 col.

**E SP:** max. 2 col.

**F DG:** numérique

Commande minimale 500 u.

**ecolutions® 1E20 Stylo**

**ecolutions® 1E21 Porte-mines**  
(consultez la page 175)

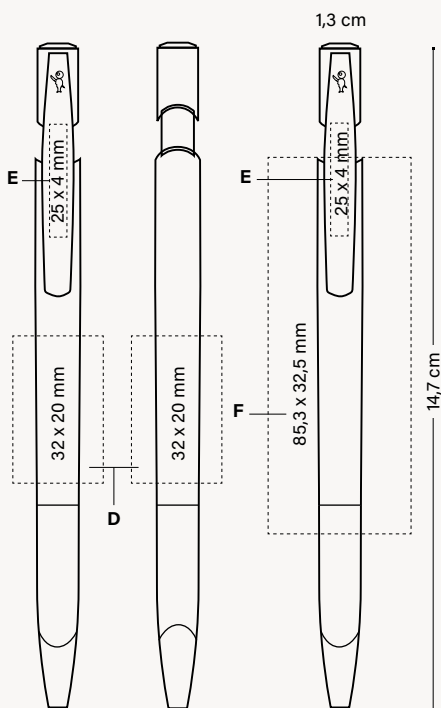

**EMBALLAGE SPÉCIAL EN OPTION**



ECO SLEEVE

+ INFO PAGES 262 À 266



PLASTIC POUCH



WINDOW BOX



500 ± 4,3 KG

*Peut être  
utilisé comme  
marque-page*

**EMBALLAGE EXTERNE**



FABRIQUÉ ET  
IMPRIMÉ DANS  
LES USINES BIC



FABRIQUÉ  
EN ESPAGNE

**TECHNIQUES D'IMPRESSION**



SÉRIGRAPHIE



DIGITAL

**MODES D'ÉCRITURE**



STYLO M  
Ø 1 MM

**DURABILITÉ**



PIÈCES  
AUTOMOBILES  
EN PLASTIQUE



LE PARTENARIAT TERRACYCLE®  
PERMET DE RECYCLER LES  
INSTRUMENTS D'ÉCRITURE BIC  
EN FRANCE

---

BIC® MEDIA CLIC

**Protection permanente  
de la surface du  
stylo contre les  
micro-organismes.**

**B**GUARD™



 **ANTIBACTERIAL™**

Protection contre  
les bactéries



Protection  
de la surface  
du stylo



Protection  
à vie



Testé selon  
un protocole  
antibactérien



1E26

1026

 **ANTIMICROBIAL™**

99,9 % de protection  
contre les bactéries  
en 24 h



93 % de  
réduction virale  
en 24 h



Inhibition des  
champignons 24 h

# BIC® MEDIA CLIC BGUARD™ ANTIBACTÉRIEN

BGUARD™



Protection contre les bactéries



Protection sur toute la surface du stylo



Protection à vie



Testé selon un protocole antibactérien



LA SOLUTION POUR UNE COMMUNICATION TOUT EN COULEURS

1026

## BIC® MEDIA CLIC BGUARD™ ANTIBACTÉRIEN

1026: logo antibactérien  
Opaque

Couleur d'encre



Encre rouge disponible sur demande



MIX & MATCH

Sans frais supplémentaires

Commande minimale 500 u.  
Combinaison de couleurs standards

### Bouton



Opaque 1BG 2BG

### Clip

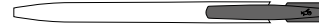

Opaque  
1BG 2BG

### Corps



Opaque  
1BG 2BG

Injection d'une couleur spéciale: ≥ 10.000 unités



L'iconique BIC® Boy et le logo antibactérien toujours visibles !

ANTIBACTERIAL™

1026

**BIC® MEDIA CLIC BGUARD™  
ANTIBACTÉRIEN**

1026: logo antibactérien

A SP: max. 2 col.  
B SP: max. 1 col.

Commande minimale 500 u.

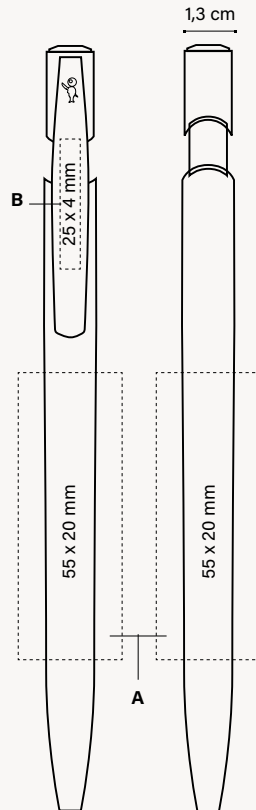

**EMBALLAGE SPÉCIAL EN OPTION**



ECO SLEEVE

+ INFO PAGES 262 À 266



PLASTIC POUCH



WINDOW BOX

*Peut être  
utilisé comme  
marque-page*

**EMBALLAGE EXTERNE**



500 ± 4,1 KG



COULEURS  
PERSONNALISÉES



FABRIQUÉ ET  
IMPRIMÉ DANS  
LES USINES BIC



FABRIQUÉ EN  
ESPAGNE



RESPECTANT  
LES NORMES



MODES  
D'ÉCRITURE



STYLO M  
Ø 1 MM

TECHNIQUES  
D'IMPRESSION



SÉRIGRAPHIE

DURABILITÉ



100 % DE L'ÉLECTRICITÉ  
PROVIENT DE SOURCES  
RENOUVELABLES



LE PARTENARIAT  
TERRACYLE® PERMET  
DE RECYCLER  
LES INSTRUMENTS  
D'ÉCRITURE BIC EN FRANCE

Consultez les pages 274-277 pour une explication détaillée des icônes.

# BIC® MEDIA CLIC BGUARD™ ANTIMICROBIAL ECOLUTIONS®



ANTIMICROBIAL™\* =



99,9 % de protection  
contre les bactéries  
en 24 h

+



93 % de  
réduction  
virale en 24 h

+



Inhibition des  
champignons 24 h

BGUARD™

ecolutions®



FABRIQUÉ À PARTIR DE 98%  
DE MATÉRIEL RECYCLÉ\*\*  
\*\*Hors système d'encre

PIÈCES AUTOMOBILES  
EN PLASTIQUE



1E26

## BIC® MEDIA CLIC BGUARD™ ANTIMICROBIAL ECOLUTIONS®

ecolutions® 1E26: logo antimicrobial  
Opaque

Couleur d'encre



Encre rouge disponible  
sur demande



3E

1E

100%

1E

100%

MIX & MATCH

Sans frais  
supplémentaires



Ajoutez la boucle mobius sur votre BAT sans  
frais additionnels. Merci de le préciser dans  
votre bon de commande (en bas à gauche  
par défaut)

Commande minimale 500 u.  
Combinaison de couleurs standards

### Bouton



Opaque 1BG 2BG

### Clip



Opaque 1BG 2BG

### Corps



Opaque 1E 3E

Injection d'une couleur spéciale: ≥ 10.000 unités



\*99,9 % des bactéries sont éliminées de la surface en 24 h (et plus de 30 % en 2 heures)

Testé selon le protocole ISO 22196 adapté à l'usage réel du stylo

93 % des virus, notamment le Sars-Cov-2 coronavirus qui provoque le Covid-19, sont éliminés de la surface en 24 heures (et environ 50 % en 2 heures).

Testé selon le protocole ISO 22196 adapté à l'usage réel du stylo

Les moisissures présentes sur la surface sont inhibées en 24 heures.

Testé selon le protocole ISO 22196 adapté aux moisissures et à l'usage réel du stylo

Vous pouvez également faire imprimer le logo anti-SARS-CoV-2. N'hésitez pas à vous renseigner auprès de votre service client !

\*\* Pourcentage calculé sur le poids total du produit cartouche exclue. En raison du contenu recyclé des matières premières avec lesquelles le produit est fabriqué, nous ne pouvons pas garantir que les couleurs qui apparaissent dans le catalogue, ni les couleurs personnalisées à la carte, aient toujours la même couleur et la même apparence.



Protection de la surface du stylo



Protection à vie



Testé selon un protocole antibactérien



Adapté au protocole de test antifongique



Protocole de test antiviral



COULEURS PERSONNALISÉES



FABRIQUÉ ET IMPRIMÉ DANS LES USINES BIC



FABRIQUÉ EN ESPAGNE



RESPECTANT LES NORMES



MODES D'ÉCRITURE



STYLO M Ø 1 MM

TECHNIQUES D'IMPRESSION



SÉRIGRAPHIE

DURABILITÉ



ecolutions®



PIÈCES AUTOMOBILES EN PLASTIQUE



100 % DE L'ÉLECTRICITÉ PROVIENT DE SOURCES RENOUVELABLES



LE PARTENARIAT TERRACYCLE® PERMET DE RECYCLER LES INSTRUMENTS D'ÉCRITURE BIC EN FRANCE

BIC GRAPHIC

INSTRUMENTS D'ÉCRITURE BIC®

AUTRES INSTRUMENTS D'ÉCRITURE

CARNETS

BRIQUETS BIC®/DIEEP® ET ÉTUIS BIC®

EMBALLAGES BIC®

INFORMATIONS GÉNÉRALES

## Personnalisation

### 1E26

**BIC® MEDIA CLIC BGUARD™ ANTIMICROBIAL ECOLUTIONS®**

ecolutions® 1E26: logo antimicrobial

**A SP:** max. 2 col.

**B SP:** max. 2 col.

Commande minimale 500 u.

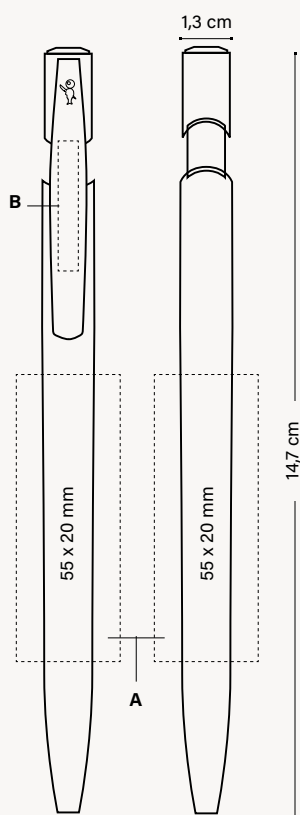

#### EMBALLAGE SPÉCIAL EN OPTION



ECO SLEEVE

+ INFO PAGES 262 À 266



PLASTIC POUCH



WINDOW BOX

#### EMBALLAGE EXTERNE



500 ± 4,1 KG

*Peut être utilisé comme marque-page*



**La première priorité pour  
le cycle de vie du stylo  
est la viabilité écologique.**

**BIOBASED**



## STYLO À BILLE FABRIQUÉ EN 69% DE MATÉRIAU BIOLOGIQUE\*

Le corps du stylo est fabriqué  
en matériau biosourcé.

Der Schaft ist aus **biobasiertem  
Material** hergestellt.



## 100% Électricité d' énergie renouvelable

100% de l'électricité de  
notre usine de production et  
d'impression **provient d'énergies  
renouvelables.**



## Transport à faible impact:

Production, impression,  
matière première.



*Fait pour durer :*

- Plus de 10000 clics.
- Plus grande visibilité  
pour votre marque.
- Clip résistant.

**69%  
Biobased**  
MATÉRIEL\*

**100%  
Biobased**  
COLORANTS

**BIOBASED** ecolutions®

FABRIQUÉ À PARTIR DE  
69 % DE MATÉRIAUX BIOSOURCÉS\*

MIX &  
MATCH



COULEURS  
PERSONNALISÉES



FABRIQUÉ ET  
IMPRIMÉ DANS  
LES USINES BIC



FABRIQUÉ EN ESPAGNE



RESPECTANT  
LES NORMES



MODES  
D'ÉCRITURE



STYLO M  
0.1 MM

TECHNIQUES  
D'IMPRESSION



SÉRIGRAPHIE



DIGITAL

DURABILITÉ



IMPRIM'VERT®

ecolutions®



CANNE  
À SUCRE



100 % DE L'ÉLECTRICITÉ  
PROVIENT DE SOURCES  
RENOUVELABLES



LE PARTENARIAT  
TERRACYCLE® PERMET  
DE RECYCLER  
LES INSTRUMENTS  
D'ÉCRITURE BIC EN FRANCE

1972

**BIC® MEDIA CLIC BIOBASED ECOLUTIONS®**

1972 Stylo

Opaque

Couleur d'encre



Encre rouge disponible sur demande

NOUVELLES COULEURS !



Disponible en  
corps blanc

britePix  
DIGITAL

\* Pourcentage calculé à partir du poids total du corps du stylo, matériaux biosourcés dans des conditions industrielles. En raison du contenu naturel des matières premières avec lesquelles le produit est fabriqué, nous ne pouvons pas garantir que les couleurs qui apparaissent dans le catalogue, ni les couleurs personnalisées à la carte, aient toujours la même couleur et la même apparence.



CANNE À SUCRE

**MIX & MATCH** Sans frais supplémentaires

### BIC® MEDIA CLIC BIOBASED ECOLUTIONS®

1972 Stylo Opaque

Commande minimale 500 u.  
Combinaison de couleurs standards

#### Bouton

Opaque 01 12 10 03 5C 2D 13 84 5G 05 3D 04 07 18 02 Givré 69

#### Clip

Opaque 01 12 10 03 5C 2D 13 5G 05 3D 04 07 18 02 Givré 69

#### Corps

Opaque

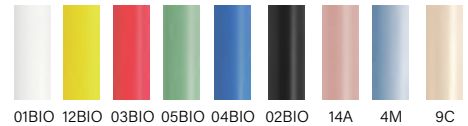

Injection d'une couleur spéciale:  
≥ 10.000 unités

1972

### BIC® MEDIA CLIC BIOBASED ECOLUTIONS®

1972

A SP: max. 2 col.

B SP: max. 2 col.

C DG: numérique

Commande minimale 500 u.

#### Personnalisation



FABRIQUÉ ET IMPRIMÉ DANS LES USINES BIC



FABRIQUÉ EN ESPAGNE

MODES D'ÉCRITURE



STYLO M  
Ø 1 MM

TECHNIQUES D'IMPRESSION



SÉRIGRAPHIE



DIGITAL

DURABILITÉ

ecolutions®



CANNE À SUCRE



LE PARTENARIAT TERRACYCLE® PERMET DE RECYCLER LES INSTRUMENTS D'ÉCRITURE BIC EN FRANCE

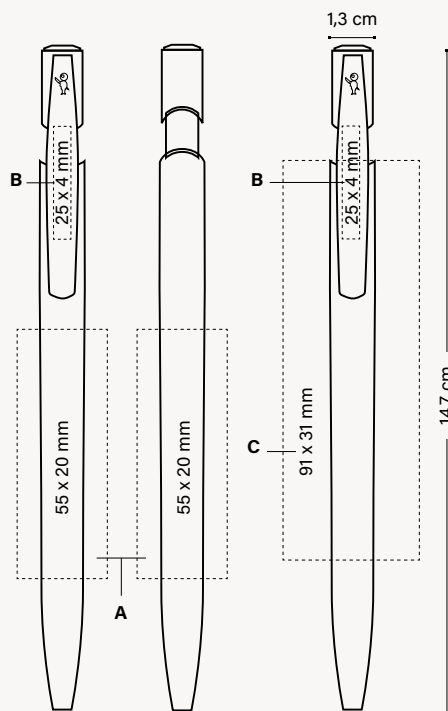

#### EMBALLAGE SPÉCIAL EN OPTION



ECO SLEEVE



PLASTIC POUCH



WINDOW BOX

#### EMBALLAGE EXTERNE



500 ± 4,3KG

+ INFO PAGES 262 À 266

Peut être utilisé comme marque-page

BIC GRAPHIC

INSTRUMENTS D'ÉCRITURE BIC®

AUTRES INSTRUMENTS D'ÉCRITURE

CARNETS

BRIQUETS BIC®/DIEEP® ET ÉTUIS BIC®

EMBALLAGES BIC®

INFORMATIONS GÉNÉRALES

\* En raison du contenu naturel des matières premières avec lesquelles le produit est fabriqué, nous ne pouvons pas garantir que les couleurs qui apparaissent dans le catalogue, ni les couleurs personnalisées à la carte, aient toujours la même couleur et la même apparence.

# BIC® MEDIA CLIC BIOBASED BGUARD™ ANTIBACTÉRIEN



COULEURS  
PERSONNALISÉES



FABRIQUÉ ET  
IMPRIMÉ DANS  
LES USINES BIC



FABRIQUÉ EN ESPAGNE



RESPECTANT  
LES NORMES



MODES  
D'ÉCRITURE



STYLO M  
Ø 1 MM

TECHNIQUES  
D'IMPRESSION



SÉRIGRAPHIE

DURABILITÉ



CANNE  
À SUCRE



100 % DE L'ÉLECTRICITÉ  
PROVIENT DE SOURCES  
RENOUVELABLES



LE PARTENARIAT  
TERRACYCLE® PERMET  
DE RECYCLER  
LES INSTRUMENTS  
D'ÉCRITURE BIC EN FRANCE

BGUARD™



Protection contre  
les bactéries



Protection  
de la surface  
du stylo



Protection  
à vie



Testé selon  
un protocole  
antibactérien

**BIOBASED** ecolutions®

FABRIQUÉ À PARTIR DE 70 %  
DE MATÉRIAUX BIOSOURCÉS\*

1973

**BIC® MEDIA CLIC BIOBASED  
BGUARD™ ANTIBACTÉRIEN**

1973 Stylo  
Opaque

Couleur d'encre



Encre rouge disponible sur demande



02



01

100%

\*Pourcentage calculé à partir du poids total du corps du stylo, matériaux biosourcés dans des conditions industrielles. En raison du contenu naturel des matières premières avec lesquelles le produit est fabriqué, nous ne pouvons pas garantir que les couleurs qui apparaissent dans le catalogue, ni les couleurs personnalisées à la carte, aient toujours la même couleur et la même apparence.





CANNE À SUCRE

**MIX & MATCH** Sans frais supplémentaires

Commande minimale 500 u. Combinaison de couleurs standards.

### Bouton

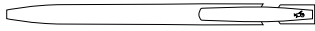

Opaque

01BG 02BG

### Clip

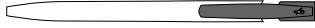

Opaque



01BG 02BG

### Corps



Opaque



01 02

Injection d'une couleur spéciale: ≥ 10.000 unités



1973

**BIC® MEDIA CLIC  
BIOBASED  
BGUARD™  
ANTIBACTÉRIEN**

1973

A SP: max. 2 col.

B SP: max. 2 col.

Commande minimale 500 u.

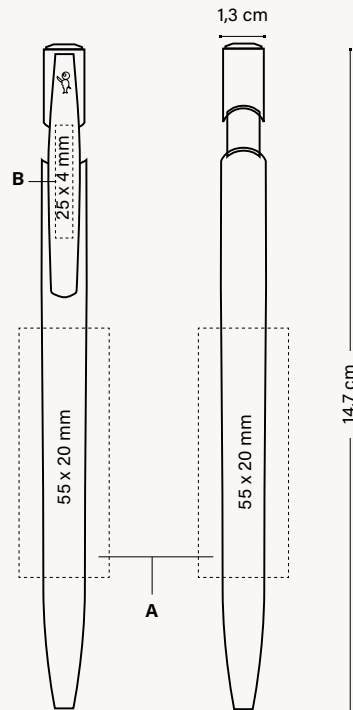

#### EMBALLAGE SPÉCIAL EN OPTION



+ INFO PAGES 262 À 266

Peut être utilisé comme marque-page

#### EMBALLAGE EXTERNE



250 ± 4,3 KG

### Personnalisation



COULEURS PERSONNALISÉES



FABRIQUÉ ET IMPRIMÉ DANS LES USINES BIC



FABRIQUÉ EN ESPAGNE

MODE D'ÉCRITURE



STYLO M  
Ø 1 MM

TECHNIQUES D'IMPRESSION



SÉRIGRAPHIE

DURABILITÉ

ecolutions®



CANNE À SUCRE



LE PARTENARIAT TERRACYCLE® PERMET DE RECYCLER LES INSTRUMENTS D'ÉCRITURE BIC EN FRANCE

Consultez les pages 274-277 pour une explication détaillée des icônes.

\*En raison du contenu naturel des matières premières avec lesquelles le produit est fabriqué, nous ne pouvons pas garantir que les couleurs qui apparaissent dans le catalogue, ni les couleurs personnalisées à la carte, aient toujours la même couleur et la même apparence.

1975

## BIC® MEDIA CLIC SHINE

1975 Stylo

Opaque

Couleur d'encre



*Encre rouge disponible sur demande*



Commande minimale 500 u. Combinaison de couleurs standards.

## Bouton

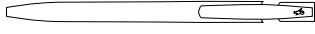

Opaque 01 12 10 03 5C 2D 13 84 5G 05 3D 04 07 18 02 Givré 69

PREMIUM

35

## Clip



Opaque 01 12 10 03 5C 2D 13 5G 05 3D 04 07 18 02 Givré 69

## Corps



Shine 26 47

## Personnalisation

1975

**BIC® MEDIA CLIC SHINE**

1975  
**A SP:** max. 2 col.  
**B SP:** max. 2 col.  
 Commande minimale 500 u.

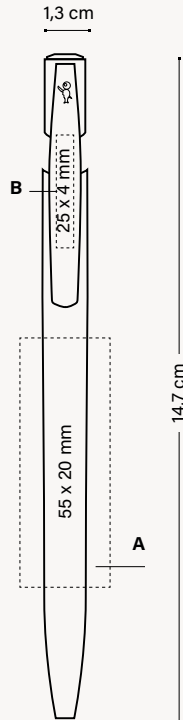

### EMBALLAGE SPÉCIAL EN OPTION



+ INFO PAGES 262 À 266

Peut être utilisé comme marque-page

### EMBALLAGE EXTERNE



500 ± 4,1 KG



MODES D'ÉCRITURE



TECHNIQUES D'IMPRESSION



SUSTAINABILITY



Consultez les pages 274-277 pour une explication détaillée des icônes.

BIC® MEDIA CLIC GLACÉ

# Des couleurs élégantes pour notre best-seller.

1030

**BIC® MEDIA CLIC GLACÉ**

1030 Opaque

Couleur d'encre



*Encre rouge disponible sur demande*



47G



76



03G



05G



04G



14G

Commande minimale 500 u.  
Combinaison de couleurs standards

## Bouton



## Clip

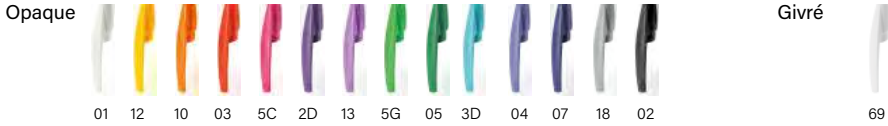

## Corps

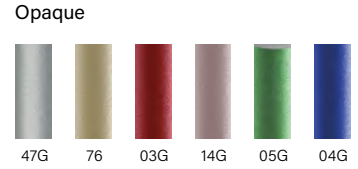

## Personnalisation

1030

### BIC® MEDIA CLIC GLACÉ

1030

A SP: max. 2 col.

B SP: max. 2 col.

Commande minimale 500 u.

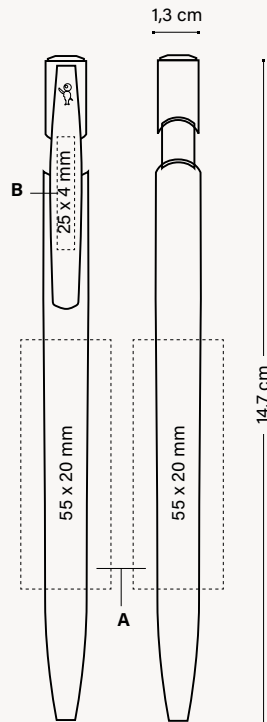

### EMBALLAGE SPÉCIAL EN OPTION



+ INFO PAGES 262 À 266



Peut être utilisé comme marque-page



### EMBALLAGE EXTERNE



### MODES D'ÉCRITURE



### TECHNIQUES D'IMPRESSION



### SUSTAINABILITY



Consultez les pages 274-277 pour une explication détaillée des icônes.



---

BIC® CLIC STIC

**Moderne, souple,  
fiable. Le BIC® Clic Stic  
est ainsi!**



*Des milliers de  
combinaisons de  
couleurs !*



1000

**BIC® CLIC STIC**  
1000 Opaque

Couleur d'encre  
● ● ●



Disponible en  
corps blanc



Version ECO.  
Comme Standard aux mêmes prix !



FABRIQUÉ À PARTIR  
DE 78% DE MATÉRIEL  
RECYCLÉ\*  
\*Hors système d'encre

CAGEOTS DE FRUITS  
ET LÉGUMES



1E00

**BIC® CLIC STIC**  
1E00 Opaque

Couleur d'encre  
● ● ●



Disponible en  
corps blanc



**MIX & MATCH**



COULEURS  
PERSONNALISÉES



FABRIQUÉ ET  
IMPRIMÉ DANS  
LES USINES BIC



FABRIQUÉ EN ESPAGNE



RESPECTANT  
LES NORMES



MODES  
D'ÉCRITURE



STYLO M  
0.1 MM

TECHNIQUES  
D'IMPRESSION



SÉRIGRAPHIE



DIGITAL

DURABILITÉ



IMPRIM'VERT®



CAGEOTS  
DE FRUITS  
ET LÉGUMES



100 % DE L'ÉLECTRICITÉ  
PROVIENT DE SOURCES  
RENOUVELABLES



LE PARTENARIAT  
TERRACYCLE® PERMET  
DE RECYCLER  
LES INSTRUMENTS  
D'ÉCRITURE BIC EN FRANCE

BIC  
GRAPHIC

INSTRUMENTS  
D'ÉCRITURE BIC®

AUTRES INSTRUMENTS  
D'ÉCRITURE

CARNETS

BRIQUETS BIC®/DIEEP®  
ET ÉTUIS BIC®

EMBALLAGES  
BIC®

INFORMATIONS  
GÉNÉRALES

\* Le pourcentage est calculé sur la base du poids total du stylo, à l'exclusion du système d'encre. En raison du contenu recyclé des matières premières avec lesquelles le produit est fabriqué, nous ne pouvons pas garantir que les couleurs qui apparaissent dans le catalogue, ni les couleurs personnalisées à la carte, aient toujours la même couleur et la même apparence.

Version ECO.  
Comme Standard  
aux mêmes prix !

ecolutions®



FABRIQUÉ À PARTIR  
DE 87% DE MATÉRIEL  
RECYCLÉ\*

\*Hors système d'encre



CAGEOTS DE FRUITS  
ET LÉGUMES

1000

BIC® CLIC STIC  
1000 Givré

Couleur d'encre  
● ● ●

Encre rouge disponible sur demande



1E00

BIC® CLIC STIC  
1E00 Givré

Couleur d'encre  
● ● ●

Encre rouge disponible  
sur demande



\* Pourcentage calculé à partir du poids total du corps du stylo. En raison du contenu recyclé des matières premières avec lesquelles le produit est fabriqué, nous ne pouvons pas garantir que les couleurs qui apparaissent dans le catalogue, ni les couleurs personnalisées à la carte, aient toujours la même couleur et la même apparence.

1005

**BIC® CLIC STIC  
SOFTFEEL®**

1005 Opaque

Couleur d'encre



*Encre rouge disponible  
sur demande*



20



07



Hexa

Hexa

100%

02

1005

**BIC® CLIC STIC  
SOFTFEEL®**

1005 Givré

Couleur d'encre



*Encre rouge disponible  
sur demande*



40

100%

**MIX &  
MATCH**



COULEURS  
PERSONNALISÉES



FABRIQUÉ ET  
IMPRIMÉ DANS  
LES USINES BIC



FABRIQUÉ EN ESPAGNE



RESPECTANT  
LES NORMES



MODES  
D'ÉCRITURE



STYLO M  
Ø 1 MM

TECHNIQUES  
D'IMPRESSION



SÉRIGRAPHIE



DIGITAL

DURABILITÉ



**ecolutions®**



CAGEOTS  
DE FRUITS  
ET LÉGUMES



100 % DE L'ÉLECTRICITÉ  
PROVIENT DE SOURCES  
RENOUVELABLES



LE PARTENARIAT  
TERRACYCLE® PERMET  
DE RECYCLER  
LES INSTRUMENTS  
D'ÉCRITURE BIC EN FRANCE

Consultez les pages 274-277 pour une explication détaillée des icônes.

**MIX & MATCH**



COULEURS PERSONNALISÉES



FABRIQUÉ ET IMPRIMÉ DANS LES USINES BIC



FABRIQUÉ EN ESPAGNE



RESPECTANT LES NORMES



**MODES D'ÉCRITURE**



STYLO M  
Ø 1 MM

**TECHNIQUES D'IMPRESSION**



SÉRIGRAPHIE



DIGITAL

**DURABILITÉ**



IMPRIM'VERT®



CAGEOTS DE FRUITS ET LÉGUMES



100 % DE L'ÉLECTRICITÉ PROVIENT DE SOURCES RENOUVELABLES



LE PARTENARIAT TERRACYCLE® PERMET DE RECYCLER LES INSTRUMENTS D'ÉCRITURE BIC EN FRANCE

Consultez les pages 274-277 pour une explication détaillée des icônes.

Version ECO.  
Comme Standard  
aux mêmes prix !

**ecolutions®**



FABRIQUÉ À PARTIR DE **87% DE MATÉRIEL RECYCLÉ\***

\*Hors système d'encre



CAGEOTS DE FRUITS ET LÉGUMES

1847

**BIC® CLIC STIC STYLUS**

1847 Opaque

Couleur d'encre



Encre rouge disponible sur demande



1846

**BIC® CLIC STIC STYLUS**

1846 Opaque

Couleur d'encre



Encre rouge disponible sur demande



\* Pourcentage calculé à partir du poids total du corps du stylo. En raison du contenu recyclé des matières premières avec lesquelles le produit est fabriqué, nous ne pouvons pas garantir que les couleurs qui apparaissent dans le catalogue, ni les couleurs personnalisées à la carte, aient toujours la même couleur et la même apparence.



Commande minimale 500 u. Combinaison de couleurs standards

## Bouton

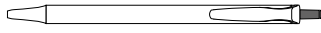

Opaque



Givré



## Clip



Opaque

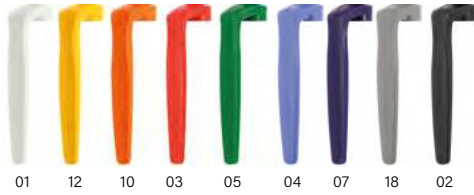

Givré



## Section

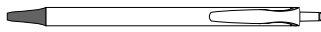

Opaque

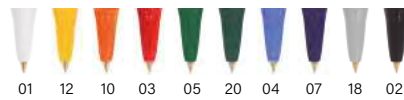

Givré

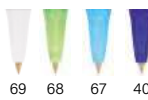

## Stylus

Opaque



## Corps



Opaque

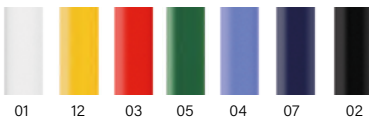

## Stylus

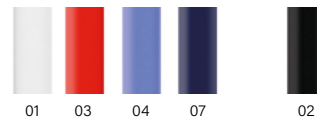

## Softfeel®

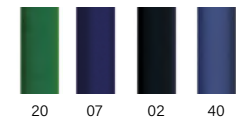

Givré

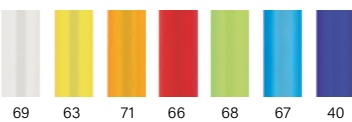

Injection d'une couleur spéciale: ≥ 10.000 unités

**ecolutions®**

Commande minimale 500 u.  
ecolutions® Combinaison de couleurs standards\*



Hors système d'encre

Ajoutez la boucle mobius sur votre BAT sans frais additionnels. Merci de le préciser dans votre bon de commande (en bas à gauche par défaut)

CAGEOTS DE FRUITS ET LÉGUMES



## Bouton

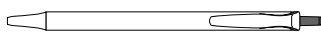

Opaque



## Section



Opaque



## Stylus

Opaque



## Clip



Opaque

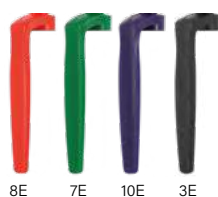

## Corps



Opaque



## Stylus

Opaque



Injection d'une couleur spéciale: ≥ 10.000 unités

\*En raison du contenu recyclé des matières premières avec lesquelles le produit est fabriqué, nous ne pouvons pas garantir que les couleurs qui apparaissent dans le catalogue, ni les couleurs personnalisées à la carte, aient toujours la même couleur et la même apparence.



COULEURS PERSONNALISÉES



FABRIQUÉ ET IMPRIMÉ DANS LES USINES BIC



FABRIQUÉ EN ESPAGNE



RESPECTANT LES NORMES



MODES D'ÉCRITURE



STYLO M Ø 1 MM

TECHNIQUES D'IMPRESSION



SÉRIGRAPHIE



DIGITAL

DURABILITÉ



IMPRIM'VERT®



CAGEOTS DE FRUITS ET LÉGUMES



100 % DE L'ÉLECTRICITÉ PROVIENT DE SOURCES RENOUVELABLES



LE PARTENARIAT TERRACYCLE PERMET DE RÉCYCLER LES INSTRUMENTS D'ÉCRITURE BIC EN FRANCE

1000 / 1E00 / 1847 / 1846

**BIC® CLIC STIC**

1000 / **ecolutions®** 1E00

**BIC® CLIC STIC STYLUS**

1847 / **ecolutions®** 1846

**A SP:** max. 3 col.

**B SP:** max. 1 col.

**C SP:** max. 2 col.

**D DG:** numérique (zone texte)

(Uniquement disponible en corps blanc)

Commande minimale 500 u.

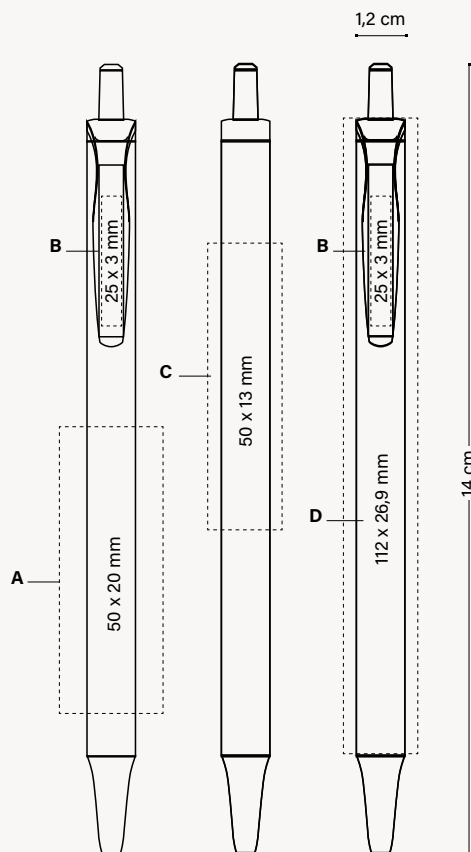

### EMBALLAGE SPÉCIAL EN OPTION



ECO SLEEVE



PLASTIC POUCH

+ INFO PAGES 262 À 266

Peut être utilisé comme marque-page

### EMBALLAGE EXTERNE



500 ± 2,9 KG

## Personnalisation

1005

**BIC® CLIC STIC SOFTFEEL®**  
1005

A/B SP: max. 1 col.

Commande minimale 500 u.

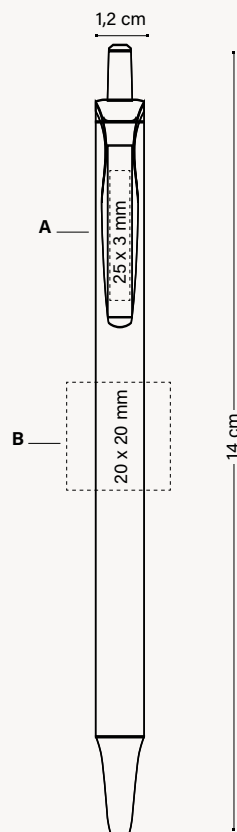

### EMBALLAGE SPÉCIAL EN OPTION



ECO SLEEVE



PLASTIC POUCH



BIC COLLECTION  
BOX SLIM PENS

*Nouveau !*

### EMBALLAGE EXTERNE



500 ± 2,9 KG

+ INFO PAGES 262 À 266

*Peut être  
utilisé comme  
marque-page*

**MIX &  
MATCH**



COULEURS  
PERSONNALISÉES



FABRIQUÉ ET  
IMPRIMÉ DANS  
LES USINES BIC



FABRIQUÉ EN ESPAGNE



RESPECTANT  
LES NORMES



ISO  
certified

MODES  
D'ÉCRITURE



STYLO M  
Ø 1 MM

TECHNIQUES  
D'IMPRESSION



SP  
SÉRIGRAPHIE



DG  
DIGITAL

DURABILITÉ



IMPRIM'VERT®



100 % DE L'ÉLECTRICITÉ  
PROVIENT DE SOURCES  
RENOUVELABLES



LE PARTENARIAT  
TERRACYCLE® PERMET  
DE RECYCLER  
LES INSTRUMENTS  
D'ÉCRITURE BIC EN FRANCE

BIC  
GRAPHIC

INSTRUMENTS  
D'ÉCRITURE BIC®

AUTRES INSTRUMENTS  
D'ÉCRITURE

CARNETS

BRIQUETS BIC®/DIEEP®  
ET ÉTUIS BIC®

EMBALLAGES  
BIC®

INFORMATIONS  
GÉNÉRALES

Consultez les pages 274-277 pour une explication détaillée des icônes.



Découvrez le clip attrayant et son mécanisme pivotant silencieux. La grande zone d'impression XXL offre une vaste gamme de possibilités de personnalisation dans la version Standard et Advance. Également dans les versions Soft et Glacé.

De plus, le BIC® Super Clip Origin est le premier stylo d'une nouvelle étape plus innovatrice et durable.

Bienvenus dans le futur !



**ECOLUTIONS®**  
**ADVANCE**  
**GLACÉ**  
**GLACÉ ADVANCE**  
**SOFT**  
**SOFT ADVANCE**  
**ORIGIN**



1039

**BIC® SUPER CLIP**  
1039 Opaque

Couleur d'encre  
● ●



Zone de  
marquage  
XXL !



Disponible en  
corps blanc





Version ECO.  
Comme Standard aux mêmes prix !

**ecolutions®**



FABRIQUÉ À PARTIR DE  
**90% DE MATÉRIEL  
RECYCLÉ\***

\*Hors système d'encre



PIÈCES AUTOMOBILES  
EN PLASTIQUE

1E50

**BIC® SUPER CLIP**  
1E50 Opaque

Couleur d'encre



1E

100%

1039

**BIC® SUPER CLIP**  
1039 Transparent

Couleur d'encre



51



87



86



89



88

100%

**MIX &  
MATCH**



COULEURS  
PERSONNALISÉES



FABRIQUÉ ET  
IMPRIMÉ DANS  
LES USINES BIC



FABRIQUÉ EN  
ESPAGNE



RESPECTANT  
LES NORMES



MODES  
D'ÉCRITURE



STYLO M  
Ø 1 MM

TECHNIQUES  
D'IMPRESSION



SÉRIGRAPHIE



DIGITAL



BRITEPIX™  
BRITEPIX™ TEXTURE  
BRITEPIX™  
PERSONNALISATION

DURABILITÉ



**ecolutions®**



PIÈCES  
AUTOMOBILES  
EN PLASTIQUE



100 % DE L'ÉLECTRICITÉ  
PROVIENT DE SOURCES  
RENOUVELABLES



LE PARTENARIAT  
TERRACIRCLE™ PERMET  
DE RECYCLER  
LES INSTRUMENTS  
D'ÉCRITURE BIC EN FRANCE

BIC  
GRAPHIC

INSTRUMENTS  
D'ÉCRITURE BIC®

AUTRES INSTRUMENTS  
D'ÉCRITURE

CARNETS

BRIQUETS BIC®/DIEEP®  
ET ÉTUIS BIC®

EMBALLAGES  
BIC®

INFORMATIONS  
GÉNÉRALES

\* Pourcentage calculé sur le poids total du produit cartouche exclue. En raison du contenu recyclé des matières premières avec lesquelles le produit est fabriqué, nous ne pouvons pas garantir que les couleurs qui apparaissent dans le catalogue, ni les couleurs personnalisées à la carte, aient toujours la même couleur et la même apparence

# BIC® SUPER CLIP

1039 / 1E50

## BIC® SUPER CLIP

1039 Opaque

ecolutions® 1E50 Opaque

1039 Transparent

Commande minimale 250 u.  
Combinaison de couleurs standards

**MIX & MATCH**

Sans frais supplémentaires

## Clip



Opaque



Transparent

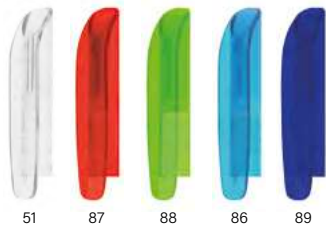

ecolutions®



PIÈCES AUTOMOBILES  
EN PLASTIQUE

Combinaison de  
couleurs standards



\*Hors système d'enclavage

Ajoutez la boucle mobius  
sur votre BAT sans frais  
additionnels. Merci de le  
préciser dans votre bon de  
commande (en bas à gauche  
par défaut)

## Corps



Opaque

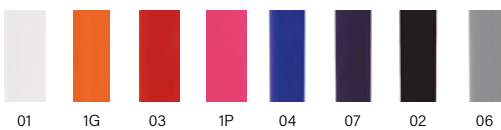

Transparent

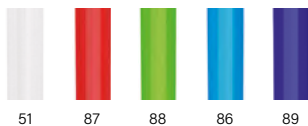

Injection d'une couleur spéciale:  $\geq 10.000$  unités



*\*En raison du contenu recyclé des matières premières avec lesquelles le produit est fabriqué, nous ne pouvons pas garantir que les couleurs qui apparaissent dans le catalogue, ni les couleurs personnalisées à la carte, aient toujours la même couleur et la même apparence*

## Personnalisation

1039 / 1E50

### BIC® SUPER CLIP

1039

ecolutions® 1E50

**A SP:** max. 2 col.

**B SP:** max. 1 col.

**C DG:** numérique

**D BP:** numérique

**BP Texture:** numérique

Commande minimale 250 u.

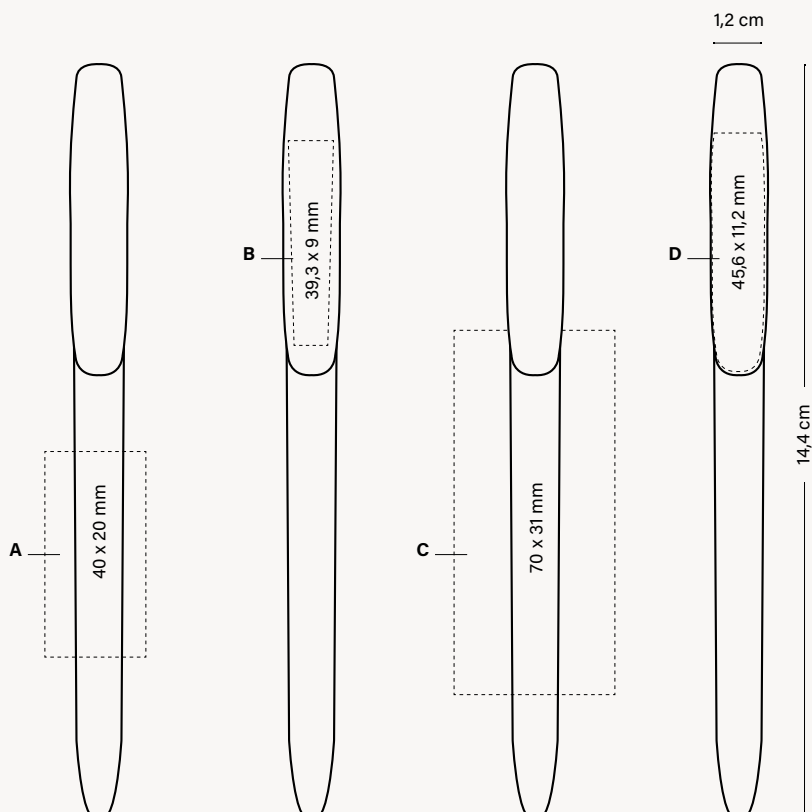

#### EMBALLAGE SPÉCIAL EN OPTION



+ INFO PAGES 262 À 266



Peut être utilisé comme marque-page



Collection Box (1, 2 et 3 unités)

#### EMBALLAGE EXTERNE



250 ± 2,6 KG

MIX & MATCH



COULEURS PERSONNALISÉES



FABRIQUÉ ET IMPRIMÉ DANS LES USINES BIC



FABRIQUÉ EN ESPAGNE



RESPECTANT LES NORMES



ISO certified

MODES D'ÉCRITURE



STYLO M Ø 1 MM

TECHNIQUES D'IMPRESSION



SP SÉRIGRAPHIE



DG DIGITAL



BRITEPIX™  
BRITEPIX™ TEXTURE  
BRITEPIX™ PERSONNALISATION

DURABILITÉ



IMPRIM'VERT®

ecolutions®



PIÈCES AUTOMOBILES EN PLASTIQUE



100 % DE L'ÉLECTRICITÉ PROVIENT DE SOURCES RENOUVELABLES



LE PARTENARIAT TERRACYCLE™ PERMET DE RECYCLER LES INSTRUMENTS D'ÉCRITURE BIC EN FRANCE

Consultez les pages 274-277 pour une explication détaillée des icônes.

BIC GRAPHIC

INSTRUMENTS D'ÉCRITURE BIC®

AUTRES INSTRUMENTS D'ÉCRITURE

CARNETS

BRIQUETS BIC®/DIEEP® ET ÉTUIS BIC®

EMBALLAGES BIC®

INFORMATIONS GÉNÉRALES

1073

## BIC® SUPER CLIP ADVANCE

1073 Opaque

Couleur d'encre





06/35

02/35

1P/35

01/35

Disponible en corps blanc



**MIX & MATCH**



COULEURS PERSONNALISÉES



FABRIQUÉ ET IMPRIMÉ DANS LES USINES BIC



FABRIQUÉ EN ESPAGNE



RESPECTANT LES NORMES



MODES D'ÉCRITURE



STYLO M Ø 1 MM

TECHNIQUES D'IMPRESSION



SÉRIGRAPHIE



DIGITAL



BRITEPIX™  
BRITEPIX™ TEXTURE  
BRITEPIX™ PERSONNALISATION

DURABILITÉ



100 % DE L'ÉLECTRICITÉ PROVIENT DE SOURCES RENOUVELABLES



LE PARTENARIAT TERRACYCLE™ PERMET DE RÉCYCLER LES INSTRUMENTS D'ÉCRITURE BIC EN FRANCE

Consultez les pages 274-277 pour une explication détaillée des icônes.

# BIC® SUPER CLIP ADVANCE

1073

## BIC® SUPER CLIP ADVANCE

1073 Opaque

Commande minimale 250 u.  
Combinaison de couleurs standards

MIX & MATCH

Sans frais supplémentaires

### Clip

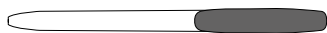

Opaque



### Corps



Opaque

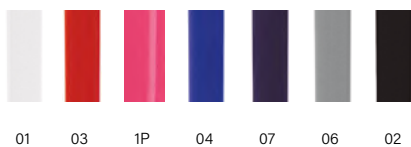

### Section

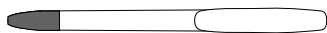

ADVANCE



35

Injection d'une couleur spéciale:  $\geq 10.000$  unités





Personnalisation

1073

**BIC® SUPER CLIP ADVANCE**

1073

**A SP:** max. 2 col.

**B SP:** max. 1 col.

**C DG:** numérique

**D BP:** numérique

**BP Texture:** numérique

Commande minimale 250 u.

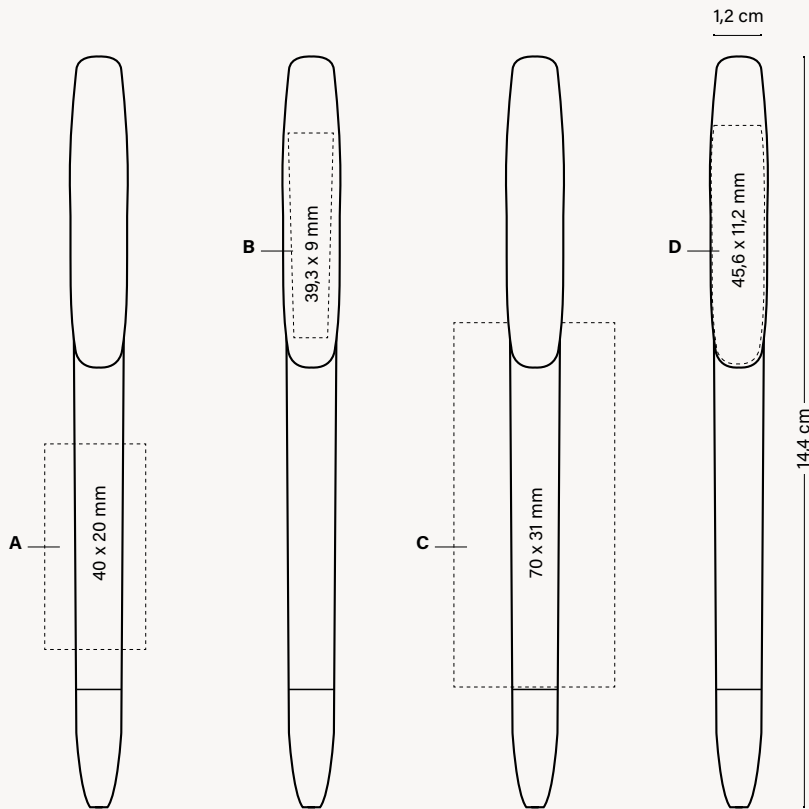

**EMBALLAGE SPÉCIAL EN OPTION**



ECO SLEEVE

+ INFO PAGES 262 À 266



PLASTIC POUCH



WINDOW BOX



COLLECTION BOX

Peut être utilisé comme marque-page

Collection Box (1, 2 et 3 unités)

**EMBALLAGE EXTERNE**



250 ± 2,6 KG



COULEURS PERSONNALISÉES



FABRIQUÉ ET IMPRIMÉ DANS LES USINES BIC



FABRIQUÉ EN ESPAGNE



RESPECTANT LES NORMES



MODES D'ÉCRITURE



STYLO M Ø 1 MM

TECHNIQUES D'IMPRESSION



SÉRIGRAPHIE



DIGITAL



BRITEPIX™  
BRITEPIX™ TEXTURE  
BRITEPIX™ PERSONNALISATION

DURABILITÉ



100 % DE L'ÉLECTRICITÉ PROVIENT DE SOURCES RENOUVELABLES



LE PARTENARIAT TERRACYCLE™ PERMET DE RÉCYCLER LES INSTRUMENTS D'ÉCRITURE BIC EN FRANCE

Consultez les pages 274-277 pour une explication détaillée des icônes.

BIC GRAPHIC

INSTRUMENTS D'ÉCRITURE BIC®

AUTRES INSTRUMENTS D'ÉCRITURE

CARNETS

BRIQUETS BIC®/DIEEP® ET ÉTUIS BIC®

EMBALLAGES BIC®

INFORMATIONS GÉNÉRALES

BIC® SUPER CLIP GLACÉ

# Découvrez le BIC® Super Clip dans sa version glamour.

1082

BIC® SUPER CLIP GLACÉ  
1082

Couleur d'encre  
● ●



1084

BIC® SUPER CLIP GLACÉ ADVANCE  
1084

Couleur d'encre  
● ●



  
Service de  
recharge sur  
demande

## Section

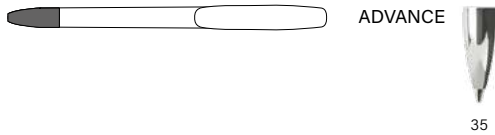

1082 / 1084

**BIC® SUPER CLIP GLACÉ**  
1082

**BIC® SUPER CLIP GLACÉ**  
**ADVANCE**  
1084

**A SP:** max. 1 col.  
**B SP:** max. 1 col.

Commande minimale 250 u.  
Combinaison de couleurs standards

## Personnalisation

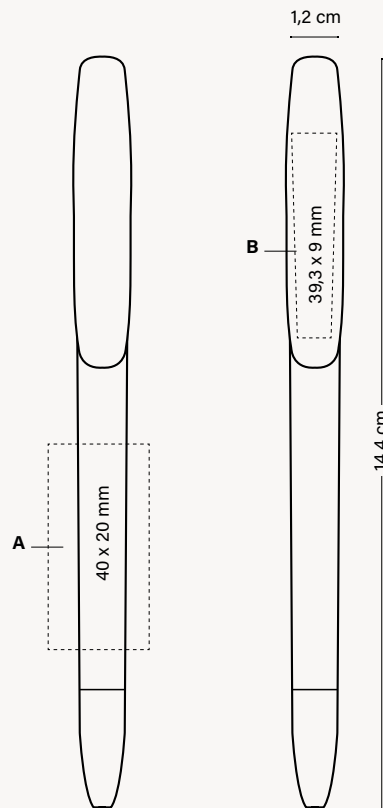

### EMBALLAGE SPÉCIAL EN OPTION



+ INFO PAGES 262 À 266

*Peut être  
utilisé comme  
marque-page*

*Collection Box  
(1, 2 et 3 unités)*

### EMBALLAGE EXTERNE



MODES  
D'ÉCRITURE



TECHNIQUES  
D'IMPRESSION



DURABILITÉ



REGARDEZ LA VIDEO

BIC  
GRAPHIC

INSTRUMENTS  
D'ÉCRITURE BIC®

AUTRES INSTRUMENTS  
D'ÉCRITURE

CARNETS

BRIQUETS BIC®/DIEEP®  
ET ÉTUIS BIC®

EMBALLAGES  
BIC®

INFORMATIONS  
GÉNÉRALES

Consultez les pages 274-277 pour une explication détaillée des icônes.

BIC® SUPER CLIP SOFT & ADVANCE

# Découvrez l'incroyable toucher soyeux de notre BIC® Super Clip avec un mécanisme rotatif.



1083

BIC® SUPER CLIP SOFT  
1083

Couleur d'encre  
● ●



1085

BIC® SUPER CLIP SOFT  
ADVANCE  
1085

Couleur d'encre  
● ●



Service de  
recharge sur  
demande

## Section

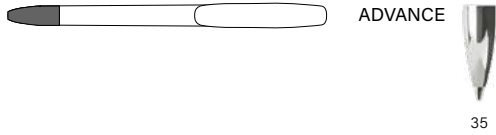

ADVANCE

35

1083 / 1085

**BIC® SUPER CLIP SOFT**  
1083

**BIC® SUPER CLIP SOFT  
ADVANCE**  
1085

A SP: max. 1 col.

Commande minimale 250 u.  
Combinaison de couleurs standards

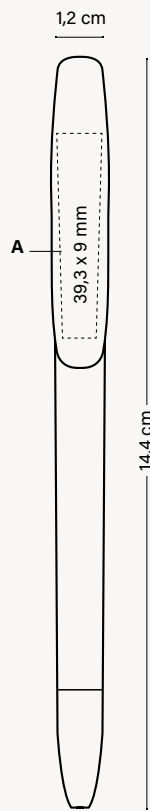

## Personnalisation



FABRIQUÉ ET  
IMPRIMÉ DANS  
LES USINES BIC



FABRIQUÉ EN  
ESPAGNE



RESPECTANT  
LES NORMES



ISO  
certified

MODES  
D'ÉCRITURE



STYLO M  
Ø 1 MM

TECHNIQUES  
D'IMPRESSION



SP  
SÉRIGRAPHIE

DURABILITÉ



IMPRIM'VERT®



100 % DE L'ÉLECTRICITÉ  
PROVIENT DE SOURCES  
RENOUVELABLES



LE PARTENARIAT  
TERRACYCLE® PERMET  
DE RÉCYCLER  
LES INSTRUMENTS  
D'ÉCRITURE BIC EN FRANCE

### EMBALLAGE SPÉCIAL EN OPTION



ECO  
SLEEVE

+ INFO PAGES 262 À 266



PLASTIC  
POUCH

Peut être  
utilisé comme  
marque-page



WINDOW  
BOX



COLLECTION  
BOX

Collection Box  
(1, 2 et 3 unités)

### EMBALLAGE EXTERNE



250 ± 2,6 KG



REGARDEZ LA VIDEO

Consultez les pages 274-277 pour une explication détaillée des icônes.

BIC  
GRAPHIC

INSTRUMENTS  
D'ÉCRITURE BIC®

AUTRES INSTRUMENTS  
D'ÉCRITURE

CARNETS

BRIQUETS BIC®/DIEEP®  
ET ÉTUIS BIC®

EMBALLAGES  
BIC®

INFORMATIONS  
GÉNÉRALES

---

BIC® SUPER CLIP ORIGIN

**Le BIC® Super Clip Origin est fabriqué à partir de matériaux biosourcés composés de polymères naturels, à l'exclusion d'éléments provenant du pétrole et de combustibles fossiles\*.**

**ORIGIN  
BIOBASED**

\* Il se réfère au corps et au clip





Fabriqué avec de l'huile de ricin et d'autres ingrédients d'origine végétale.\*



Fabriqué et imprimé dans des usines alimentées avec **100% d'électricité d'énergie renouvelable.**



**Corps et clip  
100 % biosourcés.**

6CO



Mécanisme pivotant silencieux !

*Compte tenu de l'utilisation de matériaux naturels, nos stylos présentent des variations de couleur uniques, soulignant la nature authentique et distinctive de chaque pièce. Adoptez le charme naturel !*

\* Il se réfère au corps et au clip

1038

## BIC® SUPER CLIP ORIGIN

1038 Opaque

Couleur d'encre



60



70



600

1038

**BIC® SUPER CLIP ORIGIN**

1038

A SP: max. 1 col.

Commande minimale 250 u.  
Combinaison de couleurs standards

**Personnalisation**

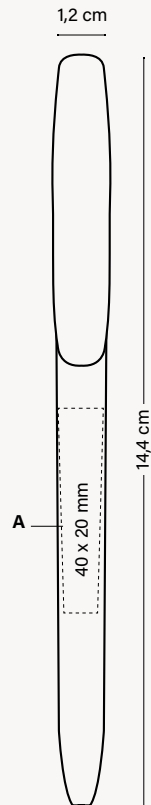

**TECHNIQUES D'IMPRESSION**



**DURABILITÉ**



**ORIGIN BIOBASED**

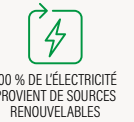

**EMBALLAGE SPÉCIAL EN OPTION**



+ INFO PAGES 262 À 266

*Peut être utilisé comme marque-page*

*Collection Box (1, 2 et 3 unités)*

**EMBALLAGE EXTERNE**



250 ± 2,6 KG



REGARDEZ LA VIDEO

Consultez les pages 274-277 pour une explication détaillée des icônes.

---

BIC® WIDE BODY™

# La taille idéale pour mettre en valeur votre marque !

Corps large et multiples  
possibilités pour optimiser  
votre communication.



07



l'iconique BIC® Boy en relief !

1080

**BIC® WIDE BODY™**

1080 Opaque

Couleur d'encre



Encre rouge disponible sur demande



01

71

02

18



impression 360°

100%

Disponible en corps blanc



1E80

**BIC® WIDE BODY™**

ecolutions® 1E80 Opaque

Couleur d'encre



Encre rouge disponible sur demande

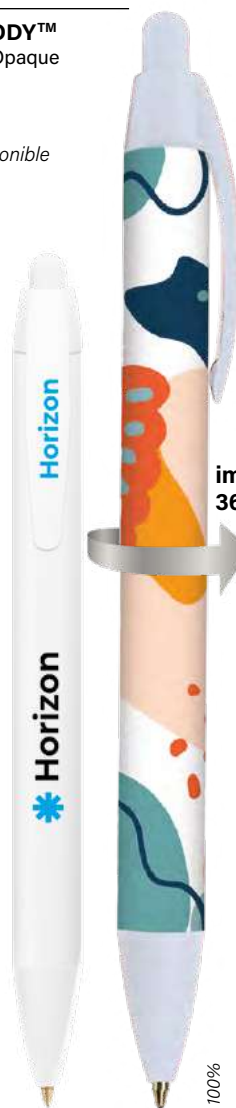

impression 360°

100%

Disponible en corps blanc



Version ECO.  
Comme Standard aux mêmes prix !

ecolutions®



FABRIQUÉ À PARTIR DE 94% DE MATÉRIEL RECYCLÉ\*

\*Du corps



CAGEOTS DE FRUITS ET LÉGUMES

MIX & MATCH



COULEURS PERSONNALISÉES



FABRIQUÉ ET IMPRIMÉ DANS LES USINES BIC



FABRIQUÉ EN ESPAGNE



RESPECTANT LES NORMES



MODES D'ÉCRITURE



STYLO M Ø 1 MM

TECHNIQUES D'IMPRESSION



SÉRIGRAPHIE



DIGITAL

DURABILITÉ



IMPRIM'VERT®

ecolutions®



CAGEOTS DE FRUITS ET LÉGUMES



100 % DE L'ÉLECTRICITÉ PROVIENT DE SOURCES RENOUVELABLES



LE PARTENARIAT TERRACYCLE® PERMET DE RECYCLER LES INSTRUMENTS D'ÉCRITURE BIC EN FRANCE

BIC GRAPHIC

INSTRUMENTS D'ÉCRITURE BIC®

AUTRES INSTRUMENTS D'ÉCRITURE

CARNETS

BRIQUETS BIC®/DIEEP® ET ÉTUIS BIC®

EMBALLAGES BIC®

INFORMATIONS GÉNÉRALES

Consultez les pages 274-277 pour une explication détaillée des icônes.

\*Pourcentage calculé sur le poids total du produit cartouche exclue. En raison du contenu recyclé des matières premières avec lesquelles le produit est fabriqué, nous ne pouvons pas garantir que les couleurs qui apparaissent dans le catalogue, ni les couleurs personnalisées à la carte, aient toujours la même couleur et la même apparence

1080

**BIC® WIDE BODY™**  
1080 Givré

Couleur d'encre



40

63

67

68

69

66

71

100%

1893

**BIC® WIDE BODY™**  
**MINI DIGITAL**  
1893 Opaque

Couleur d'encre

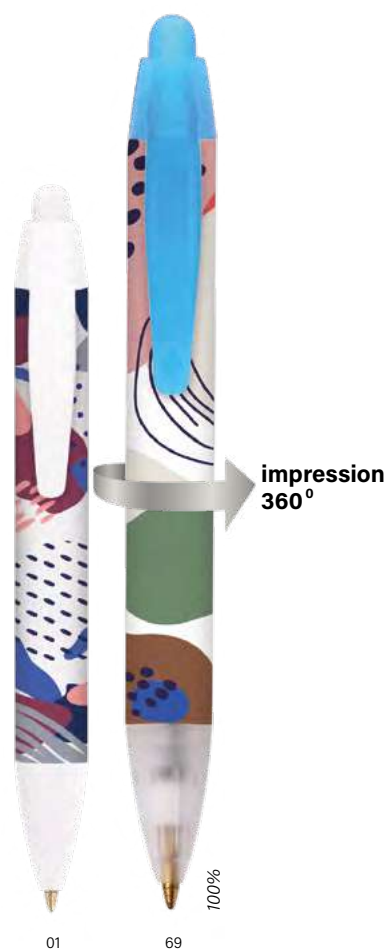

01

69

100%

Disponible en  
corps blanc





1080 / 1E80 / 1893

Commande minimale 250 u.  
Combinaison de couleurs standards

**MIX & MATCH**

Sans frais supplémentaires

### Bouton



Opaque



Givré



### Clip



Opaque

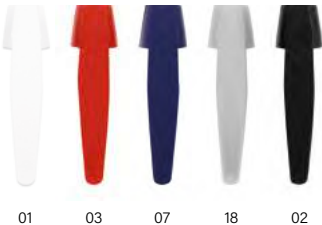

Givré

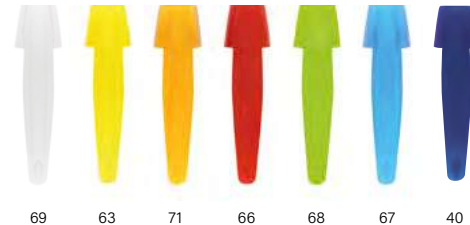

### Corps



Opaque



Givré

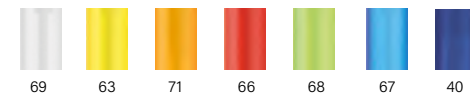

Opaque

1E

**ecolutions®**



Ajoutez la boucle mobius sur votre BAT sans frais additionnels. Merci de le préciser dans votre bon de commande (en bas à gauche par défaut)

\*Du corps



CAGEOTS DE FRUITS ET LÉGUMES

### Section



Opaque

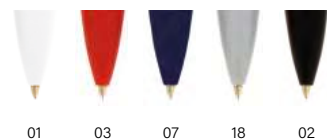

Givré

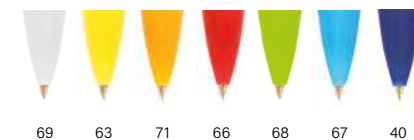

Injection d'une couleur spéciale: ≥ 10.000 unités



**MIX & MATCH**



COULEURS PERSONNALISÉES



FABRIQUÉ ET IMPRIMÉ DANS LES USINES BIC



FABRIQUÉ EN ESPAGNE



RESPECTANT LES NORMES



MODES D'ÉCRITURE



STYLO M Ø 1 MM

TECHNIQUES D'IMPRESSION



SÉRIGRAPHIE



DIGITAL

DURABILITÉ



IMPRIM'VERT®

ecolutions®



CAGEOTS DE FRUITS ET LÉGUMES



100 % DE L'ÉLECTRICITÉ PROVIENT DE SOURCES RENOUVELABLES



LE PARTENARIAT TERRACYCLE® PERMET DE RECYCLER LES INSTRUMENTS D'ÉCRITURE BIC EN FRANCE

BIC GRAPHIC

INSTRUMENTS D'ÉCRITURE BIC®

AUTRES INSTRUMENTS D'ÉCRITURE

CARNETS

BRIQUETS BIC®/DIEEP® ET ÉTUIS BIC®

EMBALLAGES BIC®

INFORMATIONS GÉNÉRALES

\* En raison du contenu recyclé des matières premières avec lesquelles le produit est fabriqué, nous ne pouvons pas garantir que les couleurs qui apparaissent dans le catalogue, ni les couleurs personnalisées à la carte, aient toujours la même couleur et la même apparence

**1080 / 1E80**

**BIC® WIDE BODY™**

1080 Opaque

ecolutions® 1E80

**A/C SP:** max. 2 col.

**B/F SP:** max. 1 col.

**D DG:** numérique (zone image)

**E DG:** numérique (zone texte)

Commande minimale 250 u. (SP)

Commande minimale 500 u. (DG)

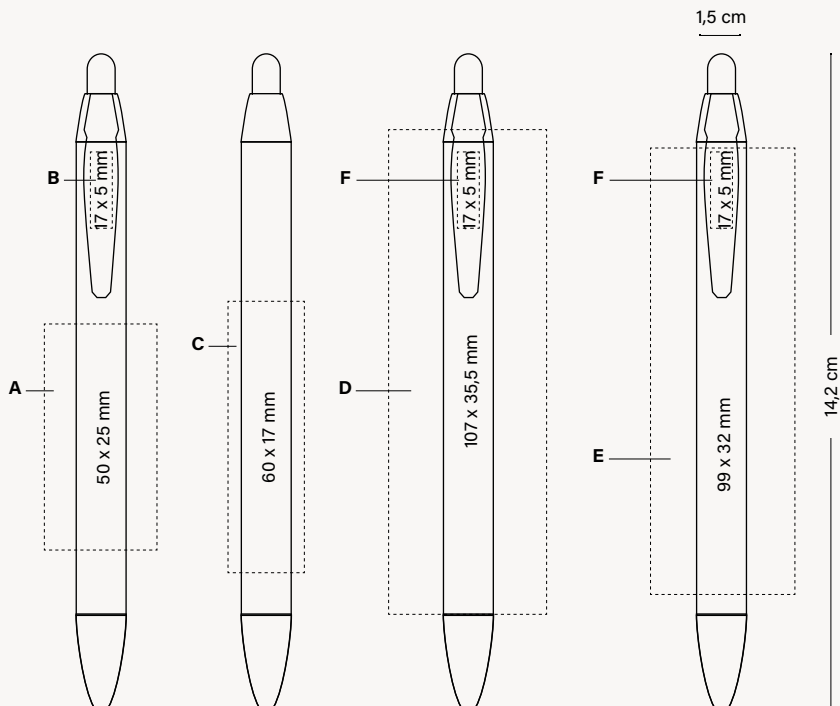

**EMBALLAGE SPÉCIAL EN OPTION**



ECO SLEEVE



PLASTIC POUCH



WINDOW BOX



COLLECTION BOX

+ INFO PAGES 262 À 266

*Peut être utilisé comme marque-page*

**EMBALLAGE EXTERNE**



250 ± 2,6KG

*Collection Box (1, 2 et 3 unités)*

Personnalisation

1893

**BIC® WIDE BODY™  
MINI DIGITAL**

1893

**A DG:** numérique (zone image)  
**B DG:** numérique (zone texte)

Commande minimale 500 u. (DG)

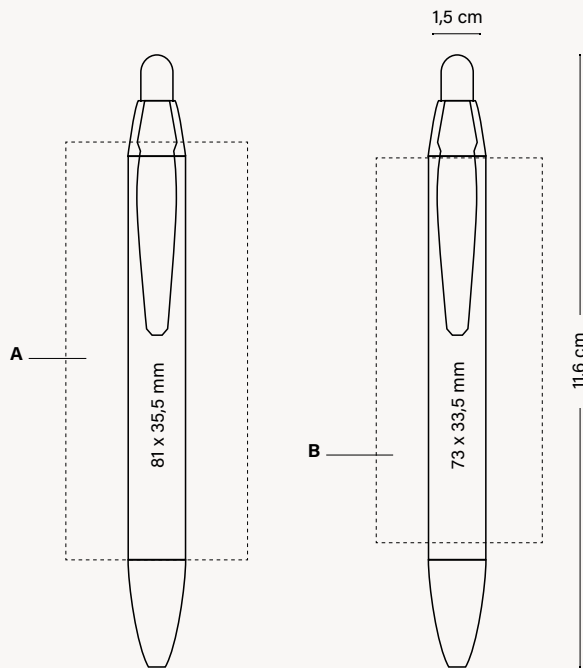

EMBALLAGE SPÉCIAL EN OPTION



+ INFO PAGES 262 À 266

Peut être utilisé comme marque-page

EMBALLAGE EXTERNE



Collection Box (1, 2 et 3 unités)



MODES D'ÉCRITURE



TECHNIQUES D'IMPRESSION



DURABILITÉ



ecolutions®



Consultez les pages 274-277 pour une explication détaillée des icônes.

BIC GRAPHIC

INSTRUMENTS D'ÉCRITURE BIC®

AUTRES INSTRUMENTS D'ÉCRITURE

CARNETS

BRIQUETS BIC®/DIEEP® ET ÉTUIS BIC®

EMBALLAGES BIC®

INFORMATIONS GÉNÉRALES

# BIC® 4 COULEURS®

Le stylo à bille de renommée mondiale le BIC® 4 Couleurs® vous offre la commodité de quatre couleurs d'encre différentes dans un seul stylo à bille. Pour plus de confort, il est doté d'un anneau pour passer un cordon, vous pouvez donc l'emporter partout avec vous.

Découvrez toutes les différentes versions: Classic, Fashion, Sun, Fine, Shine, Fluo, 3+1<sup>HB</sup> (avec porte-mines), Glacé, Soft, Wood Style et les dernières versions Rainbow Decor, Pastel, Bicolor, Gradient et Flags Collection.

Qu'attendez-vous pour commencer votre Collection ?



**RAINBOW DECOR**  
**BICOLOR**  
**GRADIENT**  
**PASTEL**  
**FASHION**  
**SUN**  
**FINE**  
**FLUO**  
**GLACÉ**  
**SHINE**  
**SOFT**  
**WOOD STYLE**  
**FLAGS COLLECTION**  
**3+1<sup>HB</sup>**

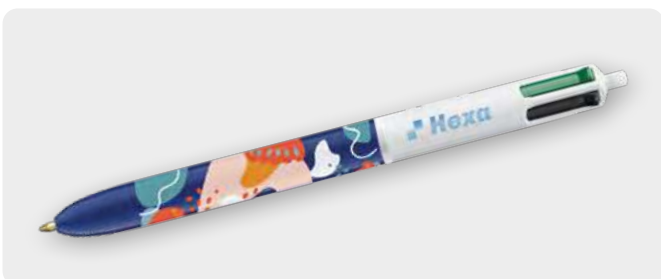

**BIC® 4 COULEURS®**

# Toujours une icône.



LA SOLUTION POUR UNE *Maintenant sur des*  
**COMMUNICATION TOUTE** *corps en couleur*  
**EN COULEURS**

1100 / 1101

**BIC® 4 COULEURS®**

1100 Opaque  
1101 Avec tour de cou

Couleur d'encre  
● ● ● ●





## Personnalisation

1100 / 1101

### BIC® 4 COULEURS®

1100/1101

- A SP:** max. 4 col.
  - B DG:** Digital print (zone image)
  - C BP:** numérique
  - D SP:** 1 col. (Uniquement disponible pour les parties supérieures blanches).
- Commande minimale 250 u. (SP, DG)  
Commande minimale 100 u. (BP)

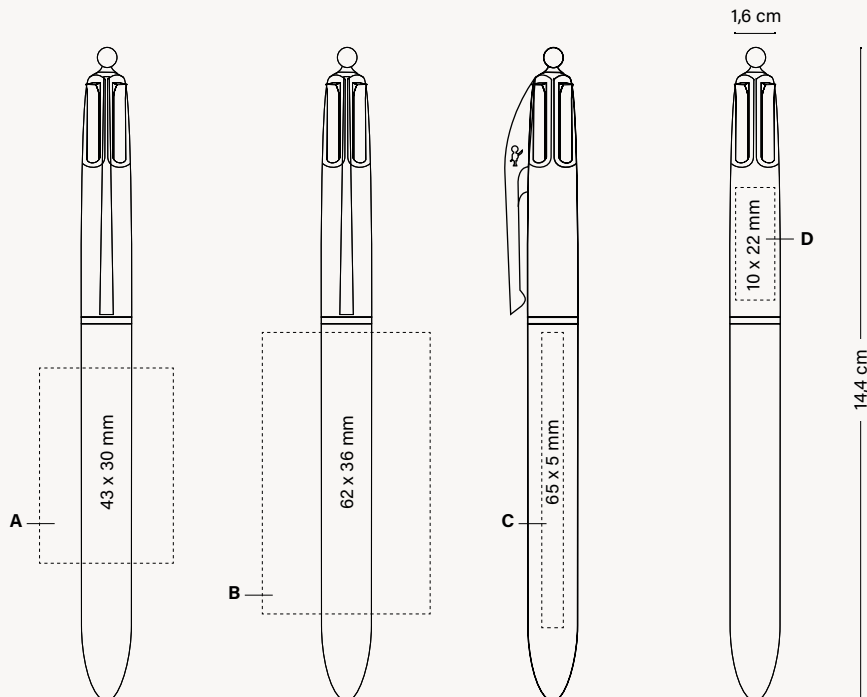

#### EMBALLAGE SPÉCIAL EN OPTION



+ INFO PAGES 262 À 266

*Peut être utilisé comme marque-page*

*Collection Box (1, 2 et 3 unités)*

#### EMBALLAGE EXTERNE



#### MODES D'ÉCRITURE



#### TECHNIQUES D'IMPRESSION



#### DURABILITÉ



LE PARTENARIAT TERRACYCLE® PERMET DE RÉCYCLER LES INSTRUMENTS D'ÉCRITURE BIC EN FRANCE

Consultez les pages 274-277 pour une explication détaillée des icônes.

BIC GRAPHIC

INSTRUMENTS D'ÉCRITURE BIC®

AUTRES INSTRUMENTS D'ÉCRITURE

CARNETS

BRIQUETS BIC®/DIEEP® ET ÉTUIS BIC®

EMBALLAGES BIC®

INFORMATIONS GÉNÉRALES

BIC® 4 COULEURS® RAINBOW DECOR

# Colorez votre monde !

Votre vie, votre style

1123 / 1124

**BIC® 4 COULEURS® RAINBOW DECOR**

1123

1124 Avec tour de cou

Couleur d'encre



**NOUVEAU !**



Service de  
recharge sur  
demande

01/9Y

Personnalisation

1123 / 1124

**BIC® 4 COULEURS® RAINBOW DECOR**  
1123/1124

**A SP:** max. 2 col.  
**B SP:** max. 1 col.

Commande minimale 250 u.

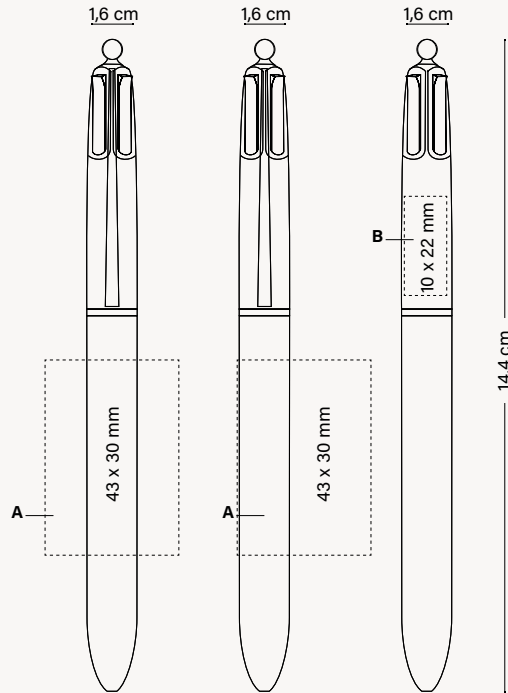

**EMBALLAGE SPÉCIAL EN OPTION**



+ INFO PAGES 262 À 266



Peut être utilisé comme marque-page



Collection Box (1, 2 et 3 unités)

**EMBALLAGE EXTERNE**



MODES D'ÉCRITURE



TECHNIQUES D'IMPRESSION



DURABILITÉ



LE PARTENARIAT TERRACYCLE® PERMET DE RECYCLER LES INSTRUMENTS D'ÉCRITURE BIC EN FRANCE



REGARDEZ LA VIDEO

BIC GRAPHIC

INSTRUMENTS D'ÉCRITURE BIC®

AUTRES INSTRUMENTS D'ÉCRITURE

CARNETS

BRIQUETS BIC®/DIEEP® ET ÉTUIS BIC®

EMBALLAGES BIC®

INFORMATIONS GÉNÉRALES

Consultez les pages 274-277 pour une explication détaillée des icônes.

**BIC® 4 COULEURS® BICOLOR**

# Une esthétique métallique avec une touche artistique.

1069 / 1076

**BIC® 4 COULEURS® BICOLOR**

1069

1076 Avec tour de cou

Couleur d'encre



01/04G/47

01/05G/47

01/80/47

01/4R/47



Service de  
recharge sur  
demande

Personnalisation

1069 / 1076

**BIC® 4 COULEURS® BICOLOR**

1069/1076

**A SP:** max. 2 col.

**B SP:** max. 1 col.

Commande minimale 250 u.

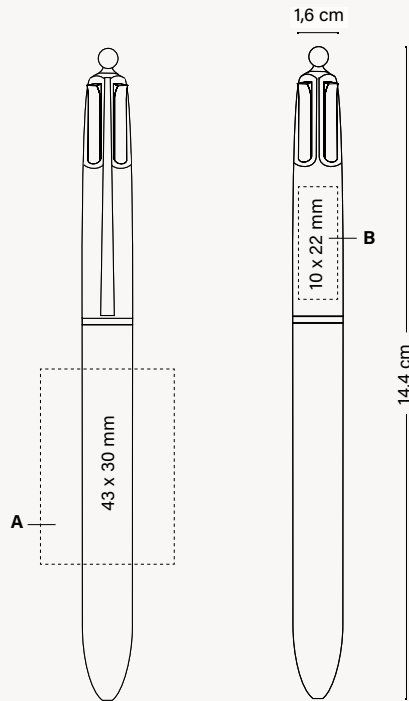

**EMBALLAGE SPÉCIAL EN OPTION**



ECO SLEEVE

+ INFO PAGES 262 À 266



PLASTIC POUCH

*Peut être utilisé comme marque-page*



WINDOW BOX



COLLECTION BOX

*Collection Box (1, 2 et 3 unités)*

**EMBALLAGE EXTERNE**



250 ± 3,2KG



COULEURS PERSONNALISÉES



FABRIQUÉ ET IMPRIMÉ DANS LES USINES BIC



FABRIQUÉ EN FRANCE



RESPECTANT LES NORMES



ISO certified

MODES D'ÉCRITURE



STYLO M Ø 1 MM

TECHNIQUES D'IMPRESSION



SÉRIGRAPHIE

DURABILITÉ



IMPRIM'VERT®



100 % DE L'ÉLECTRICITÉ PROVIENT DE SOURCES RENOUVELABLES



LE PARTENARIAT TERRACYCLE® PERMET DE RECYCLER LES INSTRUMENTS D'ÉCRITURE BIC EN FRANCE



REGARDEZ LA VIDEO

Consultez les pages 274-277 pour une explication détaillée des icônes.

BIC GRAPHIC

INSTRUMENTS D'ÉCRITURE BIC®

AUTRES INSTRUMENTS D'ÉCRITURE

CARNETS

BRIQUETS BIC®/DIEEP® ET ÉTUIS BIC®

EMBALLAGES BIC®

INFORMATIONS GÉNÉRALES

# BIC® 4 COULEURS® GRADIENT

## Un look total d'été.

1074 / 1075

**BIC® 4 COULEURS® GRADIENT**

1074

1075 Avec tour de cou

Couleur d'encre



Service de recharge sur demande

01/3G/8D/4R



Personnalisation

1074 / 1075

**BIC® 4 COULEURS® GRADIENT**

1074/1075

**A SP:** max. 2 col.

**B SP:** max. 1 col.

Commande minimale 250 u.

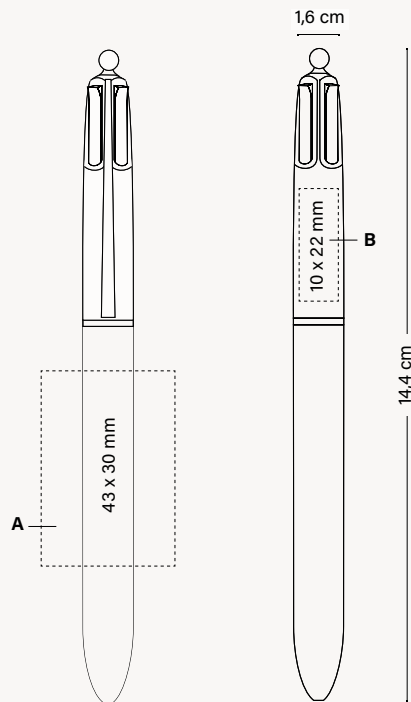

**EMBALLAGE SPÉCIAL EN OPTION**



ECO SLEEVE

+ INFO PAGES 262 À 266



PLASTIC POUCH



WINDOW BOX



COLLECTION BOX

Peut être utilisé comme marque-page

Collection Box (1, 2 et 3 unités)



250 ± 3,2KG

**EMBALLAGE EXTERNE**



COULEURS PERSONNALISÉES



FABRIQUÉ ET IMPRIMÉ DANS LES USINES BIC



FABRIQUÉ EN FRANCE



RESPECTANT LES NORMES



ISO certified

**MODES D'ÉCRITURE**



STYLO M Ø 1 MM

**TECHNIQUES D'IMPRESSION**



SP SÉRIGRAPHIE

**DURABILITÉ**



IMPRIM'VERT®



100 % DE L'ÉLECTRICITÉ PROVIENT DE SOURCES RENOUVELABLES



LE PARTENARIAT TERRACYCLE® PERMET DE RECYCLER LES INSTRUMENTS D'ÉCRITURE BIC EN FRANCE



REGARDEZ LA VIDEO

Consultez les pages 274-277 pour une explication détaillée des icônes.

BIC GRAPHIC

INSTRUMENTS D'ÉCRITURE BIC®

AUTRES INSTRUMENTS D'ÉCRITURE

CARNETS

BRIQUETS BIC®/DIEEP® ET ÉTUIS BIC®

EMBALLAGES BIC®

INFORMATIONS GÉNÉRALES

## BIC® 4 COULEURS® PASTEL

# Des couleurs vintages, tout un rêve.

1071 / 1072

### BIC® 4 COULEURS® PASTEL

1071 Opaque

1072 Avec tour de cou

Couleur d'encre



Service de  
recharge sur  
demande

Personnalisation

1071 / 1072

**BIC® 4 COULEURS® PASTEL**

1071/1072

A SP: max. 4 col.  
B DG: numérique

Commande minimale 250 u.

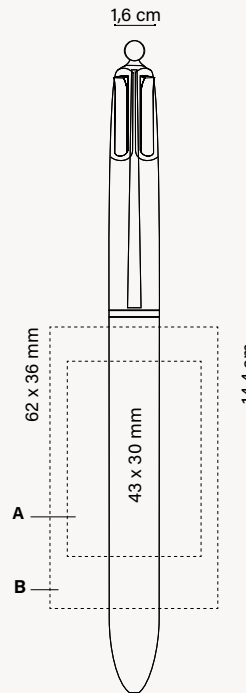

EMBALLAGE SPÉCIAL EN OPTION



ECO SLEEVE

+ INFO PAGES 262 À 266



PLASTIC POUCH

Peut être utilisé comme marque-page



WINDOW BOX



COLLECTION BOX

Collection Box (1, 2 et 3 unités)

EMBALLAGE EXTERNE



250 ± 3,2KG



COULEURS PERSONNALISÉES



FABRIQUÉ ET IMPRIMÉ DANS LES USINES BIC



FABRIQUÉ EN FRANCE



RESPECTANT LES NORMES



ISO certified

MODES D'ÉCRITURE



STYLO M Ø 1 MM

TECHNIQUES D'IMPRESSION



SP SÉRIGRAPHIE



DG DIGITAL

DURABILITÉ



IMPRIM'VERT®



100 % DE L'ÉLECTRICITÉ PROVIENT DE SOURCES RENOUVELABLES



LE PARTENARIAT TERRACYCLE® PERMET DE RÉCYCLER LES INSTRUMENTS D'ÉCRITURE BIC EN FRANCE



REGARDEZ LA VIDEO

Consultez les pages 274-277 pour une explication détaillée des icônes.

BIC GRAPHIC

INSTRUMENTS D'ÉCRITURE BIC®

AUTRES INSTRUMENTS D'ÉCRITURE

CARNETS

BRIQUETS BIC®/DIEEP® ET ÉTUIS BIC®

EMBALLAGES BIC®

INFORMATIONS GÉNÉRALES



LA SOLUTION POUR UNE  
COMMUNICATION TOUTE  
EN COULEURS

*Maintenant sur des  
corps en couleur*

**BIC® 4 COULEURS® FASHION**

1102 Opaque  
1108 Avec tour de cou

Couleur d'encre



## Personnalisation

### BIC® 4 COULEURS® FASHION 1102/1108

**A SP:** max. 4 col.

**B DG:** Digital print (zone image)

**C BP:** numérique

**D SP:** max. 1 col.

Commande minimale 250 u. (SP, DG)

Commande minimale 100 u. (BP)

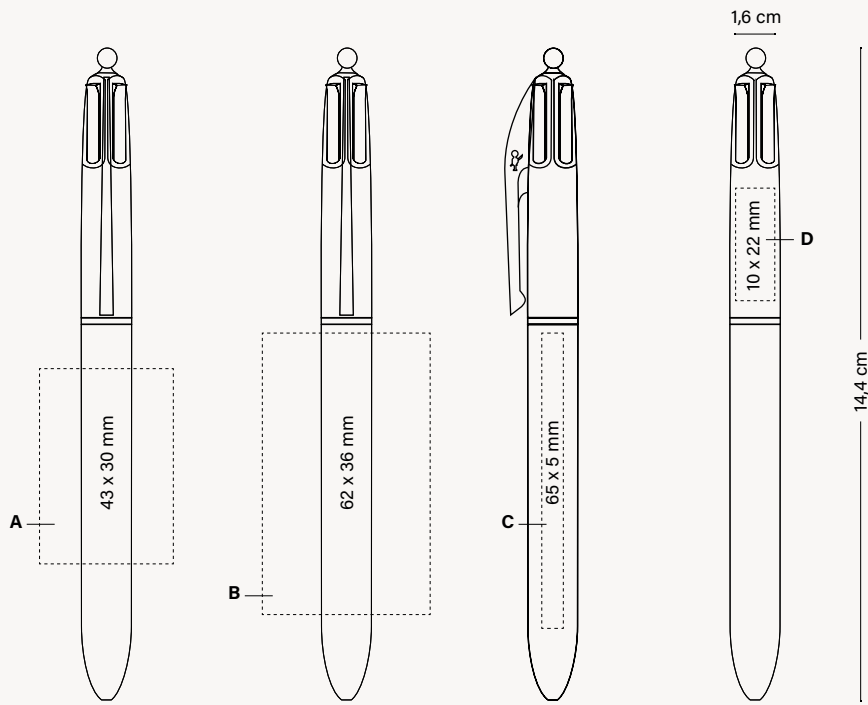

#### EMBALLAGE SPÉCIAL EN OPTION



ECO SLEEVE

+ INFO PAGES 262 À 266



PLASTIC POUCH



WINDOW BOX



COLLECTION BOX

Peut être utilisé comme marque-page

Collection Box (1, 2 et 3 unités)

#### EMBALLAGE EXTERNE



250 ± 3,2KG



COULEURS PERSONNALISÉES



FABRIQUÉ ET IMPRIMÉ DANS LES USINES BIC



FABRIQUÉ EN FRANCE



RESPECTANT LES NORMES



ISO certified

#### MODES D'ÉCRITURE



STYLO M Ø 1 MM

#### TECHNIQUES D'IMPRESSION



SP SÉRIGRAPHIE



BP BRITEPIX™  
BRITEPIX™ TEXTURE  
BRITEPIX™ PERSONNALISATION

#### DURABILITÉ



IMPRIM'VERT®  
100 % DE L'ÉLECTRICITÉ PROVIENT DE SOURCES RENOUVELABLES



LE PARTENARIAT TERRACYCLE® PERMET DE RECYCLER LES INSTRUMENTS D'ÉCRITURE BIC EN FRANCE

Consultez les pages 274-277 pour une explication détaillée des icônes.

BIC GRAPHIC

INSTRUMENTS D'ÉCRITURE BIC®

AUTRES INSTRUMENTS D'ÉCRITURE

CARNETS

BRIQUETS BIC®/DIEEP® ET ÉTUIS BIC®

EMBALLAGES BIC®

INFORMATIONS GÉNÉRALES



LA SOLUTION POUR UNE  
COMMUNICATION TOUTE  
EN COULEURS

1097 / 1098

**BIC® 4 COULEURS® SUN**

1097 Opaque

1098 Avec tour de cou

Couleur d'encre



*Flashy:  
orange et jaune*





Personnalisation

1097 / 1098

**BIC® 4 COULEURS® SUN**

1097/1098

**A SP:** max. 4 col.

**B DG:** Digital print (zone image)

**C BP:** numérique

**D SP:** max. 1 col.

Commande minimale 250 u. (SP, DG)

Commande minimale 100 u. (BP)

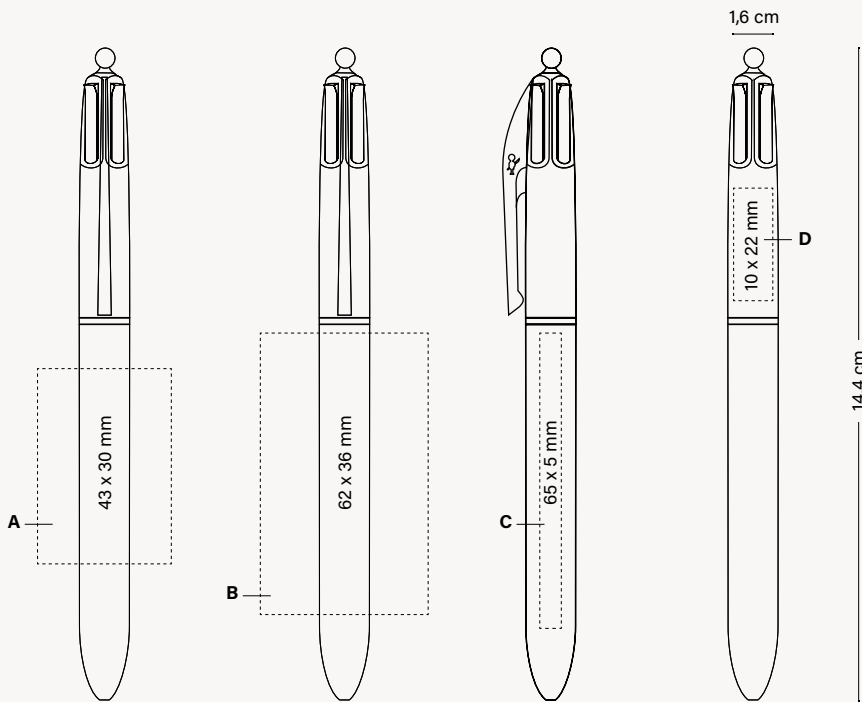

**EMBALLAGE SPÉCIAL EN OPTION**



ECO SLEEVE



PLASTIC POUCH



WINDOW BOX



COLLECTION BOX



250 ± 3,2KG

+ INFO PAGES 262 À 266

Peut être utilisé comme marque-page

Collection Box (1, 2 et 3 unités)

**EMBALLAGE EXTERNE**



**MODES D'ÉCRITURE**



**TECHNIQUES D'IMPRESSION**



**DURABILITÉ**



LE PARTENARIAT TERRACYCLE™ PERMET DE RECYCLER LES INSTRUMENTS D'ÉCRITURE BIC EN FRANCE

Consultez les pages 274-277 pour une explication détaillée des icônes.

BIC GRAPHIC

INSTRUMENTS D'ÉCRITURE BIC®

AUTRES INSTRUMENTS D'ÉCRITURE

CARNETS

BRIQUETS BIC®/DIEEP® ET ÉTUIS BIC®

EMBALLAGES BIC®

INFORMATIONS GÉNÉRALES



LA SOLUTION POUR UNE  
COMMUNICATION TOUTE  
EN COULEURS

1109 / 1111

**BIC® 4 COULEURS® FINE**

1109 Opaque

1111 Avec tour de cou

Couleur d'encre



01/10

01/10

100%



Service de  
recharge sur  
demande

↑  
Pointe de  
0,8 mm !

Personnalisation

1109 / 1111

**BIC® 4 COULEURS® FINE**

1109/1111

- A SP:** max. 4 col.
- B DG:** Digital print
- C BP:** numérique
- D SP:** max. 1 col.

Commande minimale 250 u. (SP, DG)  
Commande minimale 100 u. (BP)

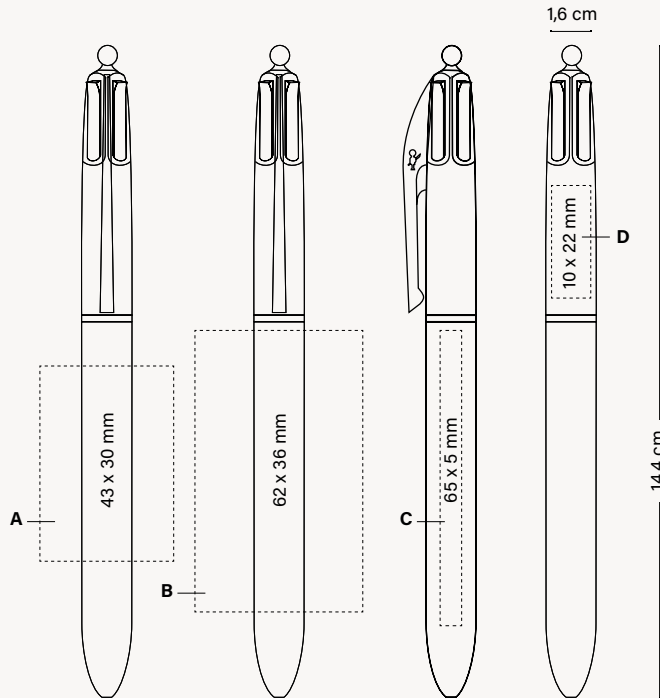

EMBALLAGE SPÉCIAL EN OPTION



+ INFO PAGES 262 À 266

Peut être utilisé comme marque-page

Collection Box (1, 2 et 3 unités)

EMBALLAGE EXTERNE



250 ± 3,2KG



MODES D'ÉCRITURE



TECHNIQUES D'IMPRESSION



BRITEPIX™ TEXTURE  
BRITEPIX™ PERSONNALISATION

DURABILITÉ



LE PARTENARIAT TERRACYCLE™ PERMET DE RECYCLER LES INSTRUMENTS D'ÉCRITURE BIC EN FRANCE

Consultez les pages 274-277 pour une explication détaillée des icônes.

BIC GRAPHIC

INSTRUMENTS D'ÉCRITURE BIC®

AUTRES INSTRUMENTS D'ÉCRITURE

CARNETS

BRIQUETS BIC®/DIEEP® ET ÉTUIS BIC®

EMBALLAGES BIC®

INFORMATIONS GÉNÉRALES

1114 / 1116

**BIC® 4 COULEURS® FLUO**

1114 Opaque  
1116 Avec tour de cou

Couleur d'encre



4 encres  
différentes  
dont 1 fluo !

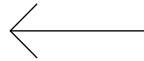

01/4D



100%



Service de  
recharge sur  
demande

Personnalisation

1114 / 1116

**BIC® 4 COULEURS® FLUO**

1114/1116

**A SP:** max. 4 col.

**B BP:** numérique

**C SP:** max. 1 col.

Commande minimale 250 u. (SP)

Commande minimale 100 u. (BP)

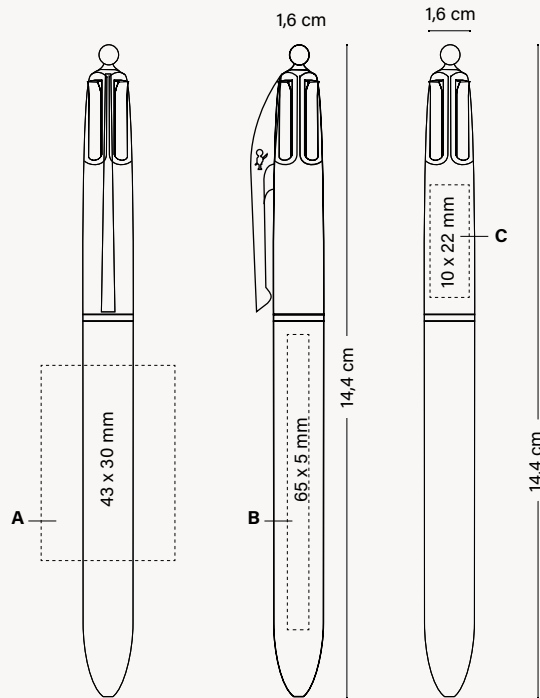

EMBALLAGE SPÉCIAL EN OPTION



ECO SLEEVE



PLASTIC POUCH



WINDOW BOX



COLLECTION BOX

+ INFO PAGES 262 À 266

Peut être utilisé comme marque-page

Collection Box (1, 2 et 3 unités)

EMBALLAGE EXTERNE



250 ± 3,2KG



MODES D'ÉCRITURE



TECHNIQUES D'IMPRESSION



DURABILITÉ



LE PARTENARIAT TERRACYCLE® PERMET DE RECYCLER LES INSTRUMENTS D'ÉCRITURE BIC EN FRANCE

Consultez les pages 274-277 pour une explication détaillée des icônes.

BIC GRAPHIC

INSTRUMENTS D'ÉCRITURE BIC®

AUTRES INSTRUMENTS D'ÉCRITURE

CARNETS

BRIQUETS BIC®/DIEEP® ET ÉTUIS BIC®

EMBALLAGES BIC®

INFORMATIONS GÉNÉRALES

BIC® 4 COULEURS® GLACÉ

# Notre stylo classique dans sa plus belle tenue.

1057 / 1058

BIC® 4 COULEURS® GLACÉ

1057

1058 Avec tour de cou

Couleur d'encre



01/76

01/47G

01/03G

01/05G

01/04G

02/47G

02/76

01/14G



Service de recharge sur demande



Personnalisation

1057 / 1058

**BIC® 4 COULEURS® GLACÉ**

1057/1058

**A SP:** max. 2 col.

**B SP:** max. 1 col. Uniquement disponible pour les parties supérieures blanches.

Commande minimale 250 u.

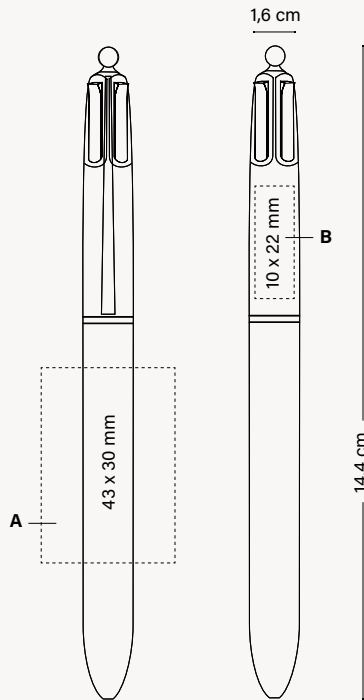

**EMBALLAGE SPÉCIAL EN OPTION**



+ INFO PAGES 262 À 266



Peut être utilisé comme marque-page

Collection Box (1, 2 et 3 unités)

**EMBALLAGE EXTERNE**



250 ± 3,2KG



**MODES D'ÉCRITURE**



**TECHNIQUES D'IMPRESSION**



**DURABILITÉ**



BIC GRAPHIC

INSTRUMENTS D'ÉCRITURE BIC®

AUTRES INSTRUMENTS D'ÉCRITURE

CARNETS

BRIQUETS BIC®/DIEEP® ET ÉTUIS BIC®

EMBALLAGES BIC®

INFORMATIONS GÉNÉRALES

Consultez les pages 274-277 pour une explication détaillée des icônes.

1106 / 1107

**BIC® 4 COULEURS® SHINE**

1106

1107 Avec tour de cou

Couleur d'encre



01/75



01/26



01/7G



01/34



01/97

*Corps super brillants !*



Service de recharge sur demande

100%

# BIC® 4 COULEURS® SHINE

1106 / 1107

**BIC® 4 COULEURS® SHINE**  
1106/1107

**A SP:** max. 2 col.  
**B LE**  
**C LE**  
**D LE:** 360°  
**E SP:** max. 1 col.

Commande minimale 250 u.

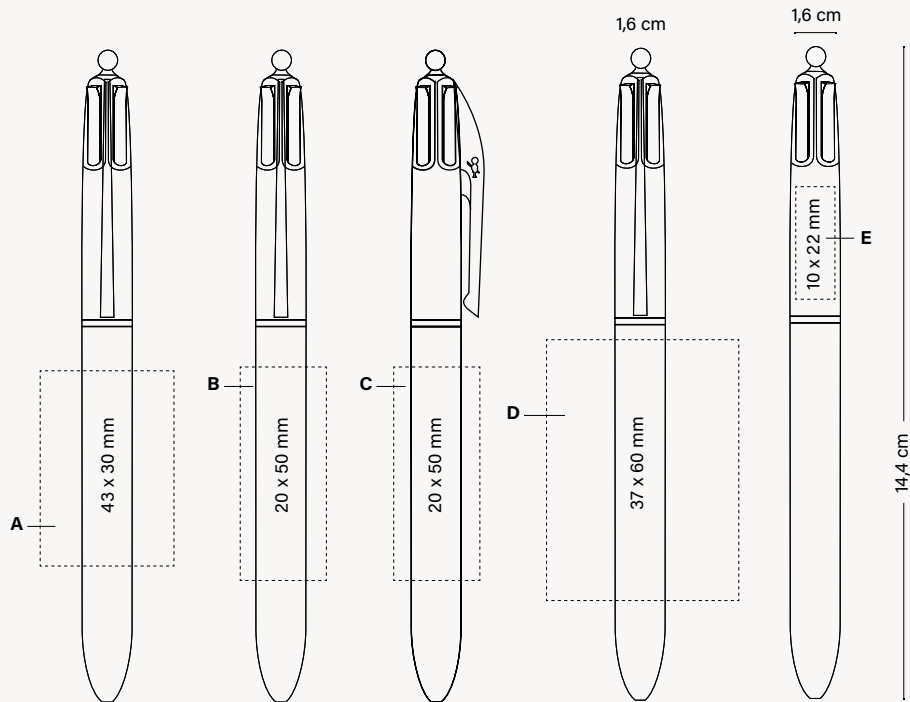

## EMBALLAGE SPÉCIAL EN OPTION



+ INFO PAGES 262 À 266

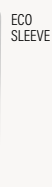

*Peut être utilisé comme marque-page*



*Collection Box (1, 2 et 3 unités)*

## EMBALLAGE EXTERNE



250 ± 3,2KG

## Personnalisation



COULEURS PERSONNALISÉES



FABRIQUÉ ET IMPRIMÉ DANS LES USINES BIC



RESPECTANT LES NORMES



ISO certified

MODES D'ÉCRITURE



STYLO M Ø 1 MM

TECHNIQUES D'IMPRESSION



SP SÉRIGRAPHIE



LE LASER

DURABILITÉ



100 % DE L'ÉLECTRICITÉ PROVIENT DE SOURCES RENOUVELABLES



LE PARTENARIAT TERRACYCLE® PERMET DE RECYCLER LES INSTRUMENTS D'ÉCRITURE BIC EN FRANCE

Consultez les pages 274-277 pour une explication détaillée des icônes.

BIC GRAPHIC

INSTRUMENTS D'ÉCRITURE BIC®

AUTRES INSTRUMENTS D'ÉCRITURE

CARNETS

BRIQUETS BIC®/DIEEP® ET ÉTUIS BIC®

EMBALLAGES BIC®

INFORMATIONS GÉNÉRALES

BIC® 4 COULEURS® SOFT



# Un toucher doux que vous ne lâcherez plus !

1060 / 1063

**BIC® 4 COULEURS® SOFT**

1060 Opaque

1063 Avec tour de cou

Couleur d'encre



01/03F

01/02F

02/02F

01/07F



*Un sentiment de douceur entre vos mains*



Service de recharge sur demande

Personnalisation

1060 / 1063

**BIC® 4 COULEURS® SOFT**

1060/1063

**A SP:** max. 1 col.

**B SP:** max. 1 col. Uniquement disponible pour les parties supérieures blanches.

Commande minimale 250 u.

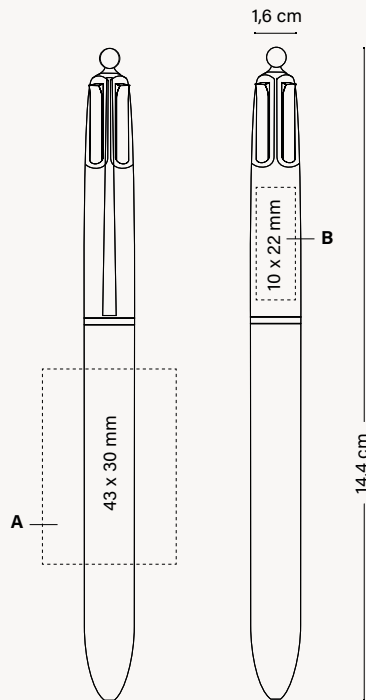

EMBALLAGE SPÉCIAL EN OPTION



ECO SLEEVE

+ INFO PAGES 262 À 266



PLASTIC POUCH



WINDOW BOX



COLLECTION BOX

Peut être utilisé comme marque-page

Collection Box (1, 2 et 3 unités)

EMBALLAGE EXTERNE



250 ± 3,2KG



COULEURS PERSONNALISÉES



FABRIQUÉ ET IMPRIMÉ DANS LES USINES BIC



FABRIQUÉ EN FRANCE



RESPECTANT LES NORMES



ISO certified

MODES D'ÉCRITURE



STYLO M Ø 1 MM

TECHNIQUES D'IMPRESSION



SÉRIGRAPHIE

DURABILITÉ



IMPRIM'VERT®



100 % DE L'ÉLECTRICITÉ PROVIENT DE SOURCES RENOUVELABLES



LE PARTENARIAT TERRACYLE® PERMET DE RECYCLER LES INSTRUMENTS D'ÉCRITURE BIC EN FRANCE

Consultez les pages 274-277 pour une explication détaillée des icônes.

BIC GRAPHIC

INSTRUMENTS D'ÉCRITURE BIC®

AUTRES INSTRUMENTS D'ÉCRITURE

CARNETS

BRIQUETS BIC®/DIEEP® ET ÉTUIS BIC®

EMBALLAGES BIC®

INFORMATIONS GÉNÉRALES

BIC® 4 COULEURS® WOOD STYLE



# Laissez-vous impressionner par cette finition spectaculaire !

1061 / 1064

BIC® 4 COULEURS® WOOD STYLE

1061 Opaque

1064 Avec tour de cou

Couleur d'encre



01/6AW

01/05W

01/02W

02/6AW

01/12W



Ajoutez de la chaleur à votre marque



Service de recharge sur demande



Personnalisation

1061 / 1064

**BIC® 4 COULEURS® WOOD STYLE**

1061/1064

**A SP:** max. 2 col.

**B SP:** max. 1 col. Uniquement disponible pour les parties supérieures blanches.

Commande minimale 250 u.

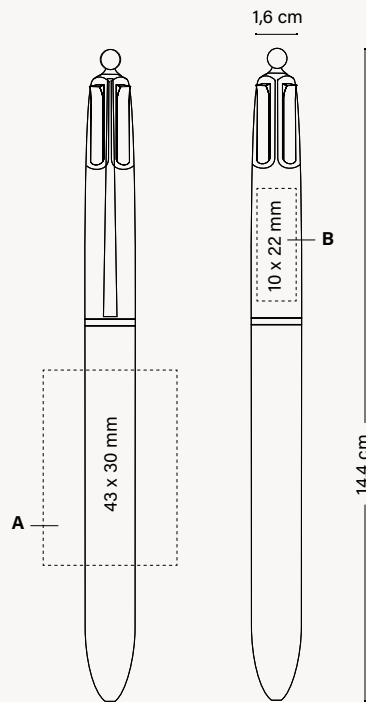

**EMBALLAGE SPÉCIAL EN OPTION**



+ INFO PAGES 262 À 266



PLASTIC POUCH



WINDOW BOX



COLLECTION BOX

*Peut être utilisé comme marque-page*

*Collection Box (1, 2 et 3 unités)*

**EMBALLAGE EXTERNE**



250 ± 3,2KG



MODES D'ÉCRITURE



TECHNIQUES D'IMPRESSION



DURABILITÉ



BIC GRAPHIC

INSTRUMENTS D'ÉCRITURE BIC®

AUTRES INSTRUMENTS D'ÉCRITURE

CARNETS

BRIQUETS BIC®/DIEEP® ET ÉTUIS BIC®

EMBALLAGES BIC®

INFORMATIONS GÉNÉRALES

Consultez les pages 274-277 pour une explication détaillée des icônes.

# BIC® 4 COULEURS® FLAGS COLLECTION

## Célébrer le patrimoine.

1067 / 1068

**BIC® 4 COULEURS® FLAGS COLLECTION**

1067

1068 Avec tour de cou

Couleur d'encre



01/03/47/05

01/02/03/12

02/02/03/12

01/03/47/04

01/03/12/03



Service de  
recharge sur  
demande

# BIC® 4 COULEURS® FLAGS COLLECTION

## Personnalisation

1067 / 1068

### BIC® 4 COULEURS® FLAGS COLLECTION

1067/1068

**A SP:** max. 2 col.

**B SP:** max. 1 col. Uniquement disponible pour les parties supérieures blanches.

Commande minimale 250 u.

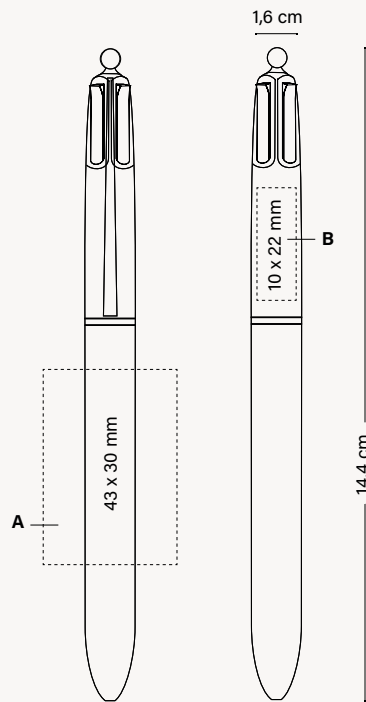

#### EMBALLAGE SPÉCIAL EN OPTION



ECO SLEEVE

+ INFO PAGES 262 À 266



PLASTIC POUCH



WINDOW BOX



COLLECTION BOX

Peut être utilisé comme marque-page

Collection Box (1, 2 et 3 unités)

#### EMBALLAGE EXTERNE



250 ± 3,2KG



COULEURS PERSONNALISÉES



FABRIQUÉ ET IMPRIMÉ DANS LES USINES BIC



FABRIQUÉ EN FRANCE



RESPECTANT LES NORMES



ISO certified

#### MODES D'ÉCRITURE



STYLO M Ø 1 MM

#### TECHNIQUES D'IMPRESSION



SÉRIGRAPHIE

#### DURABILITÉ



IMPRIM'VERT®



100 % DE L'ÉLECTRICITÉ PROVIENT DE SOURCES RENOUVELABLES



LE PARTENARIAT TERRACYCLE® PERMET DE RECYCLER LES INSTRUMENTS D'ÉCRITURE BIC EN FRANCE



REGARDEZ LA VIDEO

Consultez les pages 274-277 pour une explication détaillée des icônes.

BIC GRAPHIC

INSTRUMENTS D'ÉCRITURE BIC®

AUTRES INSTRUMENTS D'ÉCRITURE

CARNETS

BRIQUETS BIC®/DIEEP® ET ÉTUIS BIC®

EMBALLAGES BIC®

INFORMATIONS GÉNÉRALES

1099

**BIC® 4 COULEURS® 3+1<sup>HB</sup>**

1099 Opaque

Couleur d'encre



3 stylos +  
1 porte-mines



Service de  
recharge sur  
demande



1099

**BIC® 4 COULEURS® 3+1<sup>HB</sup>**

1099 Opaque

**A/B LE**

Commande minimale 250 u.

**Personnalisation**

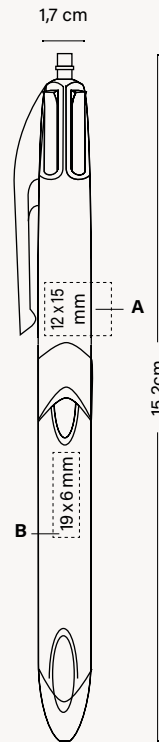

**MODES D'ÉCRITURE**



**TECHNIQUES D'IMPRESSION**



**DURABILITÉ**



**EMBALLAGE SPÉCIAL EN OPTION**



PLASTIC POUCH



COLLECTION BOX

+ INFO PAGES 262 À 266

*Peut être utilisé comme marque-page*

*Collection Box (1, 2 et 3 unités)*

**EMBALLAGE EXTERNE**



250 ± 3,5 KG



REGARDEZ LA VIDEO

Consultez les pages 274-277 pour une explication détaillée des icônes.

BIC GRAPHIC

INSTRUMENTS D'ÉCRITURE BIC®

AUTRES INSTRUMENTS D'ÉCRITURE

CARNETS

BRIQUETS BIC®/DIEEP® ET ÉTUIS BIC®

EMBALLAGES BIC®

INFORMATIONS GÉNÉRALES

BIC® METAL PRO

# Attributs métalliques, design moderne avec un grand choix de couleurs et de finitions.

1290

BIC® METAL PRO

1290 Soft

Couleur d'encre



01F



02F



04F



*Confort d'écriture maximal*



*Encre allemande,  
8 km d'écriture*

1290

**BIC® METAL PRO**  
1290 Brillant

Couleur d'encre



01E



02E



04E

100%



ASSEMBLÉ ET  
IMPRIMÉ DANS  
LES USINES BIC



ASSEMBLÉ  
EN EUROPE



RESPECTANT  
LES NORMES



ISO  
certified

**MODES  
D'ÉCRITURE**



STYLO M  
Ø 1 MM

**TECHNIQUES  
D'IMPRESSION**



SÉRIGRAPHIE



LASER

**DURABILITÉ**



IMPRIM'VERT®



LE PARTENARIAT  
TERRACYCLE® PERMET  
DE RECYCLER  
LES INSTRUMENTS  
D'ÉCRITURE BIC EN FRANCE

Consultez les pages 274-277 pour une explication détaillée des icônes.



1290

**BIC® METAL PRO**

1290 Matte

Couleur d'encre



01D



02D



04D

100%

## Personnalisation

1290

### BIC® METAL PRO

1290

**A SP:** max. 2 col.

(Non disponible en finition soft)

**B LE/SP:** max. 1 col.

**C LE 360°**

Commande minimale 50 u.

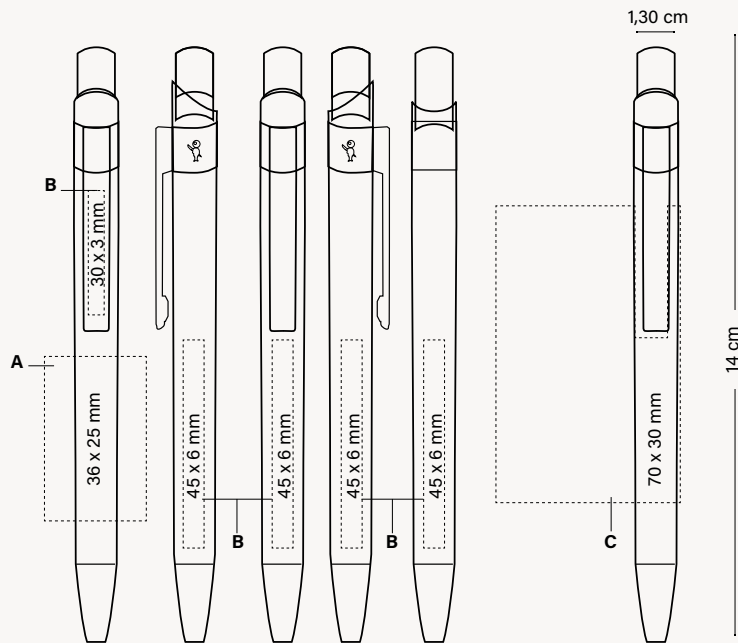

#### EMBALLAGE SPÉCIAL EN OPTION



+ INFO PAGES 240 À 245

#### EMBALLAGE EXTERNE



#### MODES D'ÉCRITURE



#### TECHNIQUES D'IMPRESSION



#### DURABILITÉ



BIC GRAPHIC

INSTRUMENTS D'ÉCRITURE BIC®

AUTRES INSTRUMENTS D'ÉCRITURE

CARNETS

BRIQUETS BIC®/DIEEP® ET ÉTUIS BIC®

EMBALLAGES BIC®

INFORMATIONS GÉNÉRALES

Consultez les pages 274-277 pour une explication détaillée des icônes.

# BIC® ROLLERS ET GELS

Profitez d'une expérience d'écriture douce, fluide et de longue durée. Parfait pour les droitiers comme pour les gauchers, il glisse facilement sur le papier et ne fait pas de tâches grâce à son encre à séchage rapide.



**BIC® GRIP ROLLER**  
**BIC® XS FINESTYLE**  
**BIC® INTENSITY® GEL CLIC**



# BIC® GRIP ROLLER

1187



ÉCRITURE MOYENNE  
Ø 0,7 MM

*Stylo roller à encre liquide, pointe moyenne  
pour une écriture fluide et agréable*

## BIC® GRIP ROLLER

1187

Couleur d'encre



100%

01/35

12/35

10/35

03/35

59/35

24/35

07/35

06/35

27/35

02/35

14/35

●  
Disponible en  
encre bleue

●  
Disponible en  
encre bleue

●  
Disponible en  
encre bleue

Personnalisation

1187

**BIC® GRIP ROLLER**

1187

A/B SP: max. 3 col.

Commande minimale 250 u.

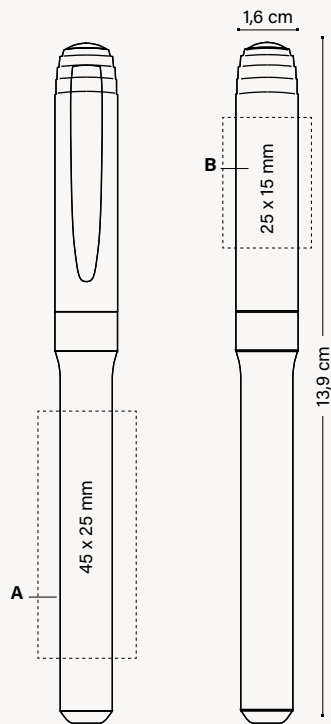

MODES D'ÉCRITURE



TECHNIQUES D'IMPRESSION



DURABILITÉ



EMBALLAGE SPÉCIAL EN OPTION



ECO SLEEVE

+ INFO PAGES 240 À 245



PLASTIC POUCH



WINDOW BOX



MARKING SET



COLLECTION BOX

*Peut être utilisé comme marque-page*

*Collection Box (1, 2 et 3 unités)*

EMBALLAGE EXTERNE



250 ± 3 KG

Consultez les pages 274-277 pour une explication détaillée des icônes.

1851

**BIC® XS FINESTYLE**  
1851 Opaque

Couleur d'encre



01/03



01/25



01/06

●  
Uniquement disponible  
en encre noire

1851

**BIC® XS FINESTYLE**  
1851 Transparent

Couleur d'encre



89/01

100%



## Personnalisation

1851

### BIC® XS FINESTYLE

1851

**A PD:** max. 2 col.

**B SP:** max. 2 col.

**C BP:** Numérique

Commande minimale 250 u.

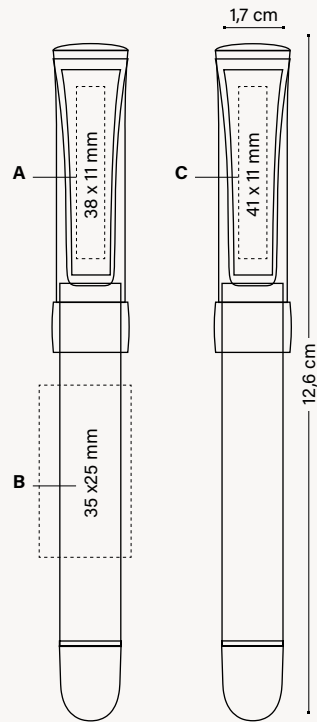

#### EMBALLAGE SPÉCIAL EN OPTION



ECO SLEEVE

+ INFO PAGES 240 À 245



PLASTIC POUCH

*Peut être utilisé comme marque-page*

#### EMBALLAGE EXTERNE



250 ± 2,8KG



FABRIQUÉ ET IMPRIMÉ DANS LES USINES BIC



FABRIQUÉ EN ESPAGNE



RESPECTANT LES NORMES



ISO certified

#### MODES D'ÉCRITURE



ÉCRITURE FINESTYLE Ø 0,7 MM

#### TECHNIQUES D'IMPRESSION



SÉRIGRAPHIE



TAMPOGRAPHIE



BRITEPIX™  
BRITEPIX™ TEXTURE  
BRITEPIX™ PERSONALISATION

#### DURABILITÉ



IMPRIM'VERT®



100 % DE L'ÉLECTRICITÉ PROVIENT DE SOURCES RENOUVELABLES



LE PARTENARIAT TERRACYCLE® PERMET DE RÉCYCLER LES INSTRUMENTS D'ÉCRITURE BIC EN FRANCE

BIC GRAPHIC

INSTRUMENTS D'ÉCRITURE BIC®

AUTRES INSTRUMENTS D'ÉCRITURE

CARNETS

BRIQUETS BIC®/DIEEP® ET ÉTUIS BIC®

EMBALLAGES BIC®

INFORMATIONS GÉNÉRALES

Consultez les pages 274-277 pour une explication détaillée des icônes.

1196



**BIC® INTENSITY®  
GEL CLIC**  
1196 Opaque

Couleur d'encre  
● ●



01



02

100%

1196

**BIC® INTENSITY®  
GEL CLIC**  
1196 Transparent

Couleur d'encre  
● ●



92



88



86

100%

## Personnalisation

1196

### BIC® INTENSITY® GEL CLIC

1196

**A SP:** max. 2 col.

**B SP:** max. 4 col.

Commande minimale 250 u.

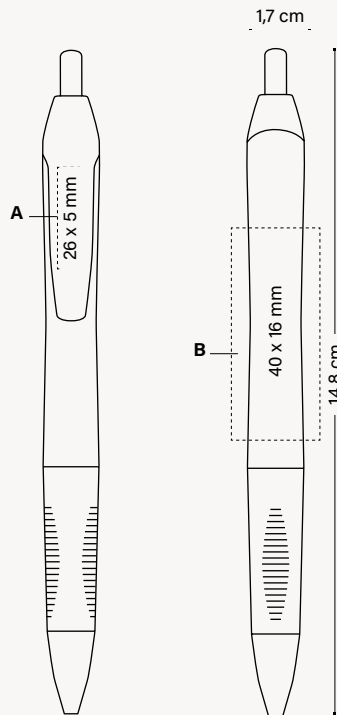

#### EMBALLAGE SPÉCIAL EN OPTION



PLASTIC  
POUCH

+ INFO PAGES 240 À 245

*Remboursé  
à la commande  
sur présentation  
de la facture*

#### EMBALLAGE EXTERNE



250 ± 3,7KG



MODES  
D'ÉCRITURE



TECHNIQUES  
D'IMPRESSION



DURABILITÉ



BIC  
GRAPHIC

INSTRUMENTS  
D'ÉCRITURE BIC®

AUTRES INSTRUMENTS  
D'ÉCRITURE

CARNETS

BRIQUETS BIC®/DIEEP®  
ET ÉTUIS BIC®

EMBALLAGES  
BIC®

INFORMATIONS  
GÉNÉRALES

Consultez les pages 274-277 pour une explication détaillée des icônes.

# SURLIGNEURS ET MARQUEURS BIC®

---

Les surligneurs et les marqueurs BIC® ont été conçus pour écrire d'une manière visible sur une large gamme de surfaces.

Exprimez-vous avec clarté sur n'importe quelle surface.



- BIC® BRITE LINER® GRIP**
- BIC® VELLEDA® WHITE BOARD MARKER FINE**
- BIC® VELLEDA® WHITE BOARD MARKER GRIP**
- BIC® MARK-IT PERMANENT MARKER**
- BIC® PERMANENT MARKER ECOLUTIONS®**



1192

BIC® BRITE LINER® GRIP  
1192



Personnalisation

1192

**BIC® BRITE LINER® GRIP**

1192

A/B SP: max. 3 col.

Commande minimale 250u.

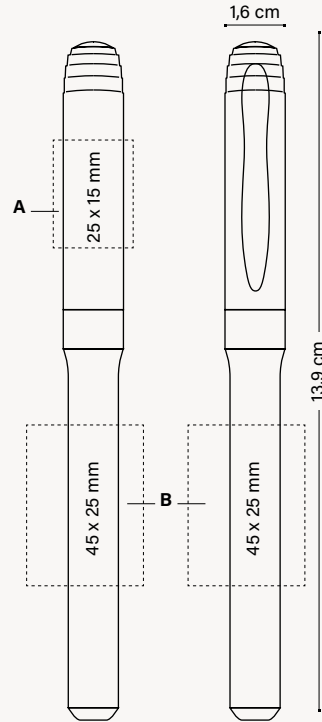

EMBALLAGE SPÉCIAL EN OPTION



MARKING SET

+ INFO PAGES 262 À 266

Peut être utilisé comme marque-page



COLLECTION BOX

Collection Box (1, 2 et 3 unités)

EMBALLAGE EXTERNE



250 ± 2,8KG



MODES D'ÉCRITURE



TECHNIQUES D'IMPRESSION



CONVIENT POUR



DURABILITÉ



LE PARTENARIAT TERRACYCLE® PERMET DE RECYCLER LES INSTRUMENTS D'ÉCRITURE BIC EN FRANCE

Consultez la page 274-277 pour une explication détaillée des icônes

BIC GRAPHIC

INSTRUMENTS D'ÉCRITURE BIC®

AUTRES INSTRUMENTS D'ÉCRITURE

CARNETS

BRIQUETS BIC®/DIEEP® ET ÉTUIS BIC®

EMBALLAGES BIC®

INFORMATIONS GÉNÉRALES





1651

**BIC® VELLEDA® WHITE BOARD MARKER FINE**  
1651



01/04  
●  
Couleur d'encre



01/02  
●  
Couleur d'encre

100%

1651

**BIC® VELLEDA® WHITE BOARD MARKER FINE**  
1651

A SP: max. 1 col.

Commande minimale 500u.

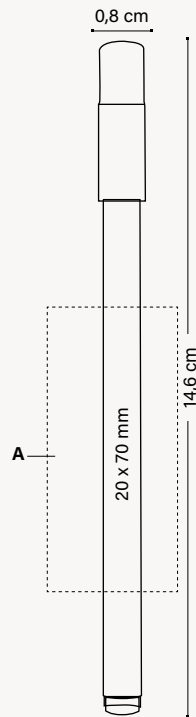

**EMBALLAGE SPÉCIAL EN OPTION**



MARKING SET

*Disponible en set !*

+ INFO PAGES 262 À 266

*Peut être utilisé comme marque-page*

**EMBALLAGE EXTERNE**



500 ± 3,2KG



FABRIQUÉ ET IMPRIMÉ DANS LES USINES BIC®



FABRIQUÉ EN FRANCE



RESPECTANT LES NORMES



MINE RÉSISTANTE



**MODES D'ÉCRITURE**



MARQUEUR POINTE OGIVE MK

**TECHNIQUES D'IMPRESSON**



SÉRIGRAPHIE

**DURABILITÉ**



LE PARTENARIAT TERRACYCLE® PERMET DE RECYCLER LES INSTRUMENTS D'ÉCRITURE BIC EN FRANCE

# BIC® VELLEDA® WHITE BOARD MARKER GRIP

Velleda®

Personnalisation

1213

**BIC® VELLEDA® WHITE BOARD MARKER GRIP**  
1213

A/B SP: max. 3 col.

Commande minimale 250u.

1213

**BIC® VELLEDA® WHITE BOARD MARKER GRIP**  
1213



→  
*Grip en caoutchouc pour plus de précision et de contrôle*

100%

01/02

●  
Couleur d'encre

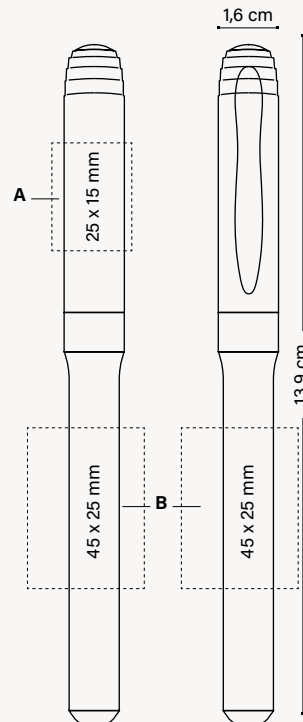

EMBALLAGE SPÉCIAL EN OPTION



MARKING SET

+ INFO PAGES 262 À 266

*Peut être utilisé comme marque-page*

EMBALLAGE EXTERNE



250 ± 2,7KG

*Disponible en set !*



FABRIQUÉ ET IMPRIMÉ DANS LES USINES BIC®



RESPECTANT LES NORMES



MINE RÉSISTANTE

MODES D'ÉCRITURE



MARQUEUR POINTE OGIVE MK

TECHNIQUES D'IMPRESSION



SÉRIGRAPHIE

DURABILITÉ



IMPRIM'VERT®



LE PARTENARIAT TERRACYCLE® PERMET DE RECYCLER LES INSTRUMENTS D'ÉCRITURE BIC EN FRANCE

1214

**BIC® MARK-IT  
PERMANENT  
MARKER**  
1214



01/02

●  
Couleur  
d'encre

01/04

●  
Couleur  
d'encre

100%

Grip en caoutchouc  
pour plus  
de précision  
et de contrôle

Personnalisation

1214

**BIC® MARK-IT  
PERMANENT MARKER**  
1214

A/B SP: max. 3 col.

Commande minimale 250u.

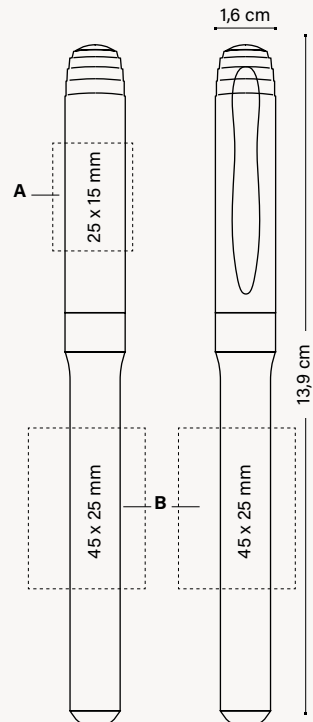

EMBALLAGE SPÉCIAL EN OPTION

EMBALLAGE EXTERNE



MARKING  
SET

Maintenant  
disponible  
en set !



250 ± 2,8KG

+ INFO PAGES 240 À 245

Peut être  
utilisé comme  
marque-page



FABRIQUÉ ET  
IMPRIMÉ DANS  
LES USINES BIC®



RESPECTANT  
LES NORMES



MINE  
RÉSISTANTE

MODES D'ÉCRITURE



MARQUEUR POINTE  
OGIVE MK

TECHNIQUES D'IMPRESSION



SÉRIGRAPHIE

DURABILITÉ



IMPRIM'VERT®



LE PARTENARIAT TERRACYCLE®  
PERMET DE RECYCLER LES  
INSTRUMENTS D'ÉCRITURE BIC  
EN FRANCE

# BIC® PERMANENT MARKER ECOLUTIONS®

ecolutions



FABRIQUÉ À PARTIR DE  
**52% DE MATÉRIEL RECYCLÉ\***

Ajoutez la boucle mobius sur votre BAT sans frais additionnels. Merci de le préciser dans votre bon de commande (en bas à gauche par défaut)

\*Hors système d'encre



EMBALLAGES PHARMACEUTIQUES

Personnalisation

1210

**BIC® PERMANENT MARKER**

ecolutions® 1210

A SP: max. 1 col.

Commande minimale 250u.

1210

**BIC® PERMANENT MARKER**

ecolutions® 1210



02

●  
Couleur d'encre

02

●  
Couleur d'encre

100%

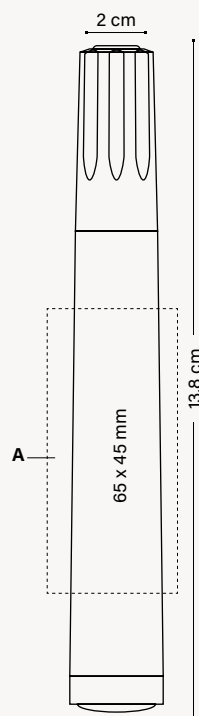

EMBALLAGE EXTERNE



250 ± 2,6KG



FABRIQUÉ ET IMPRIMÉ DANS LES USINES BIC®



FABRIQUÉ EN FRANCE



RESPECTANT LES NORMES



MINE RÉSISTANTE



MODES D'ÉCRITURE



MARQUEUR POINTE OGIVE MK

TECHNIQUES D'IMPRESSION



SÉRIGRAPHIE

DURABILITÉ



EMBALLAGES PHARMACEUTIQUES



LE PARTENARIAT TERRACYLE® PERMET DE RECYCLER LES INSTRUMENTS D'ÉCRITURE BIC EN FRANCE



\*Pourcentage calculé sur le poids total du produit cartouche exclue. En raison du contenu recyclé des matières premières avec lesquelles le produit est fabriqué, nous ne pouvons pas garantir que les couleurs qui apparaissent dans le catalogue, ni les couleurs personnalisées à la carte, aient toujours la même couleur et la même apparence. Consultez la page 250 pour une explication détaillée des icônes.

# PORTE-MINES BIC®

Toujours prêts avec ces porte-mines de grande qualité. Ils sont solides et leurs mines sont résistantes. Ils n'ont pas besoin d'être taillés et offrent une écriture plus fluide et plus intense que jamais !



**BIC® MATIC®**  
**BIC® MEDIA CLIC PORTE-MINES**  
**BIC® MEDIA CLIC GRIP PORTE-MINES**



Version ECO. Comme Standard aux mêmes prix !

ecolutions®



FABRIQUÉ À PARTIR DE  
**74% DE MATÉRIEL\* RECYCLÉ\***

Ajoutez la boucle mobius sur votre BAT sans frais additionnels. Merci de le préciser dans votre bon de commande (en bas à gauche par défaut).

\*Hors plomb



EMBALLAGES  
PHARMACEUTIQUES

1120

BIC® MATIC®  
1120 Opaque



02/02

12/12

03/03

07/07

01/01

100%

1E40

BIC® MATIC®  
ecolutions® 1E40 Opaque



04/8C

100%

\* Pourcentage calculé sur le poids total du porte-mine, hors mines. En raison du contenu recyclé des matières premières avec lesquelles le produit est fabriqué, nous ne pouvons pas garantir que les couleurs qui apparaissent dans le catalogue, ni les couleurs personnalisées à la carte, aient toujours la même couleur et la même apparence.



Personnalisation

1120 / 1E40

**BIC® MATIC®**

1120

**ecolutions®** 1E40

A SP: max. 1 col.

B/C: max. 2 col.

Commande minimale 500u.

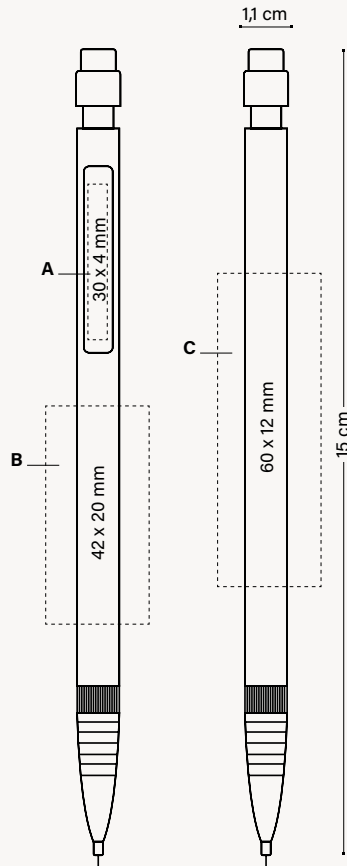

**EMBALLAGE SPÉCIAL EN OPTION**



PLASTIC  
POUCH

+ INFO PAGES 240 À 245

*Peut être  
utilisé comme  
marque-page*

**EMBALLAGE EXTERNE**



500 ± 3,1 KG



RESPECTANT  
LES NORMES



ÉCRITURE PLUS  
DOUCE ET FONCÉE



FACILE À UTILISER  
ET À EFFACER



2 MINES DE 9 CM

**MODES  
D'ÉCRITURE**



PORTE-MINES MP  
Ø 0,7 MM

**TECHNIQUES  
D'IMPRESSION**



SÉRIGRAPHIE

**DURABILITÉ**



IMPRIM'VERT®



ecolutions®



EMBALLAGES  
PHARMACEUTIQUES



LE PARTENARIAT  
TERRACYCLE® PERMET  
DE RECYCLER  
LES INSTRUMENTS  
D'ÉCRITURE BIC EN FRANCE

Consultez la page 274-277 pour une explication détaillée des icônes

BIC  
GRAPHIC

INSTRUMENTS  
D'ÉCRITURE BIC®

AUTRES INSTRUMENTS  
D'ÉCRITURE

CARNETS

BRIQUETS BIC®/DIEEP®  
ET ÉTUIS BIC®

EMBALLAGES  
BIC®

INFORMATIONS  
GÉNÉRALES

1028



*L'iconique BIC® Boy  
en relief !*

---

**BIC® MEDIA CLIC**

1028 Porte-mines  
Opaque



13



5C

1028

---

**BIC® MEDIA CLIC**

1028 Porte-mines  
Givré



39

Version ECO.  
Comme Standard aux mêmes prix !

ecolutions®



FABRIQUÉ À PARTIR DE 98%  
DE MATÉRIEL RECYCLÉ\*  
\*Du corps



PIÈCES AUTOMOBILES  
EN PLASTIQUE

## 1021

**BIC® MEDIA CLIC GRIP**  
1021 Porte-mines  
Givré



71/69

82/69

40/69

100%

## 1E21

**BIC® MEDIA CLIC GRIP**  
1E21 Porte-mines  
Opaque



01/03

01/05

01/02

01/07

100%

\* Pourcentage calculé sur le poids total du produit. En raison du contenu recyclé des matières premières avec lesquelles le produit est fabriqué, nous ne pouvons pas garantir que les couleurs qui apparaissent dans le catalogue, ni les couleurs personnalisées à la carte, aient toujours la même couleur et la même apparence.

# BIC® MEDIA CLIC PORTE-MINES

1028

**BIC® MEDIA CLIC**  
1028 Porte-mines

1021 / 1E21

**BIC® MEDIA CLIC GRIP**  
1021 Porte-mines  
eColutions® 1E21 Porte-mines

**MIX & MATCH** Sans frais supplémentaires

Commande minimale 500 u.  
eColutions® Combinaison de couleurs standards

## Clip



Opaque

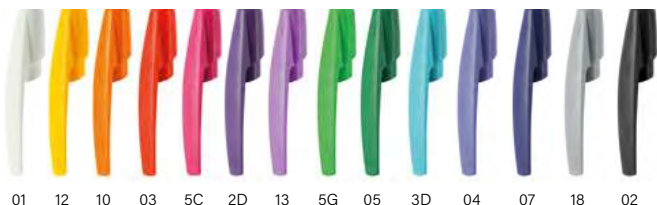

Givré



01 12 10 03 5C 2D 13 5G 05 3D 04 07 18 02 69

## Corps



Opaque



5C 13

Givré



39

## Corps et Grip

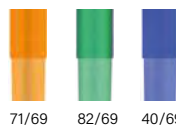

71/69 82/69 40/69

**britePix DIGITAL** LA SOLUTION POUR UNE COMMUNICATION TOUT EN COULEURS

**eColutions®**



PIÈCES AUTOMOBILES EN PLASTIQUE

Combinaison de couleurs standards\*

**Corps et Grip**

Opaque



01/03 01/05 01/07 01/02



Ajoutez la boucle mobius sur votre BAT sans frais additionnels. Merci de le préciser dans votre bon de commande (en bas à gauche par défaut)

Toute la gamme de couleurs est disponible en Digital BritePix™

Injection d'une couleur spéciale: ≥ 10.000 unités 1028  
Injection d'une couleur spéciale: ≥ 20.000 unités 1021 / 1E21



**MIX & MATCH**



FABRIQUÉ ET IMPRIMÉ DANS LES USINES BIC®



COULEURS PERSONNALISÉES

MODES D'ÉCRITURE



PORTE-MINE MP

TECHNIQUES D'IMPRESSION



SP SÉRIGRAPHIE



DG DIGITAL

DURABILITÉ



PIÈCES AUTOMOBILES EN PLASTIQUE



LE PARTENARIAT TERRACYCLE® PERMET DE RECYCLER LES INSTRUMENTS D'ÉCRITURE BIC EN FRANCE

Personnalisation

1028

**BIC® MEDIA CLIC**

1028 Porte-mines

A SP: max. 4 col.

B SP: max. 2 col.

C DG: numérique

Commande minimale 500 u.

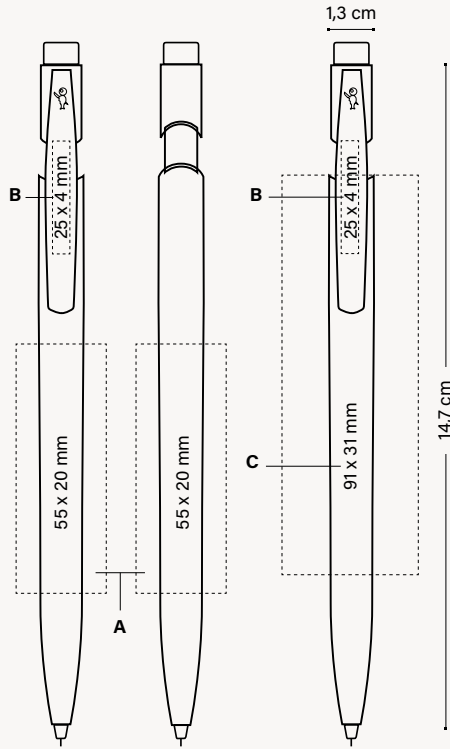

EMBALLAGE SPÉCIAL EN OPTION



ECO SLEEVE



PLASTIC POUCH



WINDOW BOX

+ INFO PAGES 262 À 266

Peut être utilisé comme marque-page

EMBALLAGE EXTERNE



500 ± 4,1 KG

Personnalisation

1021 / 1E21

**BIC® MEDIA CLIC GRIP**

1021 Porte-mines

1E21 Porte-mines

D SP: max. 4 col.

E SP: max. 2 col.

F DG: numérique

Commande minimale 500 u.

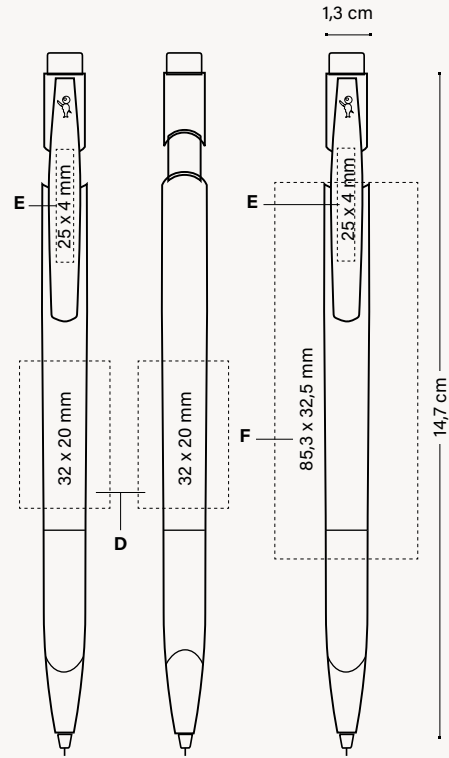

EMBALLAGE SPÉCIAL EN OPTION



ECO SLEEVE



PLASTIC POUCH



WINDOW BOX

+ INFO PAGES 262 À 266

Peut être utilisé comme marque-page

EMBALLAGE EXTERNE



500 ± 4,3 KG



FABRIQUÉ ET IMPRIMÉ DANS LES USINES BIC®



FABRIQUÉ EN ESPAGNE

MODES D'ÉCRITURE



PORTE-MINE MP

TECHNIQUES D'IMPRESSION



SÉRIGRAPHIE



DIGITAL

DURABILITÉ



PIÈCES AUTOMOBILES EN PLASTIQUE



LE PARTENARIAT TERRACYCLE® PERMET DE RECYCLER LES INSTRUMENTS D'ÉCRITURE BIC EN FRANCE

# **CRAYONS BIC<sup>®</sup> ET BIC<sup>®</sup> KIDS EVOLUTION<sup>®</sup> COLOURING SET**

**Graphite and colouring pencils made from synthetic resin and wood-free, that will not splinter in the event of breaking.**



**CRAYONS BIC®  
BIC® KIDS EVOLUTION®  
COLOURING SET**





# BIC® EVOLUTION® ECOLUTIONS®

**Evolution®** **ecolutions®**



LA SOLUTION POUR  
UNE COMMUNICATION  
TOUTE EN COULEURS !



LA SOLUTION POUR  
UNE COMMUNICATION  
TOUTE EN COULEURS !



l'icône BIC®  
Boy et logo BIC®  
en relief !



FABRIQUÉ À PARTIR DE  
**64% DE MATÉRIEL RECYCLÉ\***



RÉFRIGÉRATEURS  
ET DE POTS  
DE YAOURTS



FABRIQUÉ À PARTIR DE  
**52% DE MATÉRIEL RECYCLÉ\***



RÉFRIGÉRATEURS  
ET DE POTS  
DE YAOURTS

1150

**CRAYON  
SANS GOMME  
ecolutions® 1150**



100%



100%

impression  
360°

1151

**CRAYON  
AVEC GOMME  
ecolutions® 1151**



100%



100%

impression  
360°



Protecteur  
de mine



\* Pourcentage calculé sur le poids total du produit. En raison du contenu recyclé des matières premières avec lesquelles le produit est fabriqué, nous ne pouvons pas garantir que les couleurs qui apparaissent dans le catalogue, ni les couleurs personnalisées à la carte, aient toujours la même couleur et la même apparence.



FABRIQUÉ ET IMPRIMÉ DANS LES USINES BIC



RESPECTANT LES NORMES



MINE RÉSISTANTE



PAS D'ÉCHARDES EN CAS DE BRISURE



PROTECTEUR DE MINE



FACILE À UTILISER ET À EFFACER

MODES D'ÉCRITURE



CRAYON PC HB Ø 2,3MM

TECHNIQUES D'IMPRESSION



SÉRIGRAPHIE



DIGITAL

DURABILITÉ



ecolutions®



LE PARTENARIAT TERRACYCLE® PERMET DE RECYCLER LES INSTRUMENTS D'ÉCRITURE BIC EN FRANCE

Consultez la page 274-277 pour une explication détaillée des icônes



FABRIQUÉ À PARTIR DE 64% DE MATÉRIEL\*\* RECYCLÉ\*



Ajoutez la boucle mobius sur votre BAT sans frais additionnels. Merci de le préciser dans votre bon de commande (en bas à gauche par défaut)

1150 / 1151

CRAYON AVEC ET SANS GOMME 1150/1151



Sans frais supplémentaires

Commande minimale 500u. Combinaison de couleurs standards

Gomme



Opaque



Virole



Opaque



Corps



Opaque

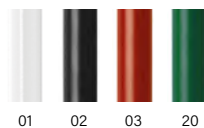

\*\* Les pourcentages indiqués dans la boucle de Möbius dépendent du produit sélectionné (1150 ou 1151). Voir les détails dans la description du produit.

1150

**BIC® EVOLUTION® ECOLUTIONS®**  
**ecolutions® 1150** (Crayon sans gomme)

A SP: max. 1 col.

Commande minimale 500u.

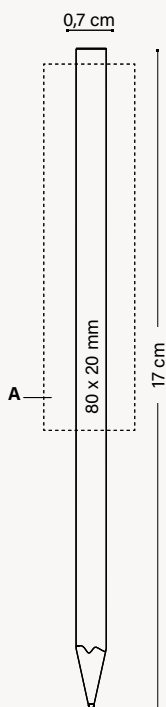

1151

**BIC® EVOLUTION® ECOLUTIONS®**  
**ecolutions® 1151** (Crayon avec gomme)

Commande minimale 500u.

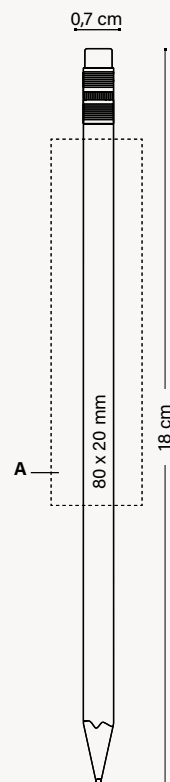

**EMBALLAGE SPÉCIAL EN OPTION**



PLASTIC  
 POUCH  
 (x 3 UNITÉS)

+ INFO PAGES 262 À 266

*Peut être  
 utilisé comme  
 marque-page*

**EMBALLAGE EXTERNE**



500 ± 3,5 KG

Personnalisation

1150

**BIC® EVOLUTION® ECOLUTIONS®**  
**ECOLUTIONS® 1150** (Crayon sans gomme  
 impression numérique)

**A DG:** Numérique (zone image)  
 Commande minimale 500u.

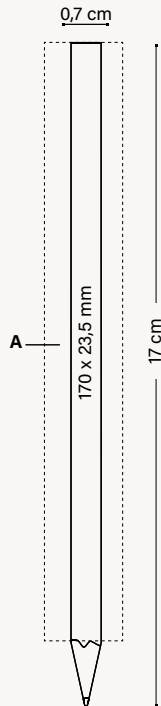

1151

**BIC® EVOLUTION® ECOLUTIONS®**  
**ECOLUTIONS® 1151** (Crayon avec gomme  
 impression numérique)

Commande minimale 500u.

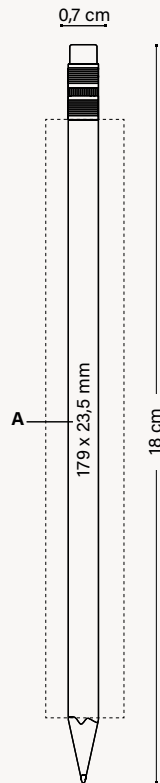

EMBALLAGE SPÉCIAL EN OPTION



PLASTIC  
 POUCH  
 (X 3 UNITÉS)

+ INFO PAGES 262 À 266

*Peut être  
 utilisé comme  
 marque-page*

EMBALLAGE EXTERNE



500 ± 3,5 KG



FABRIQUÉ ET  
 IMPRIMÉ DANS  
 LES USINES BIC



RESPECTANT  
 LES NORMES



MINE RÉSISTANTE



PAS D'ÉCHARDES  
 EN CAS DE BRISURE



PROTECTEUR  
 DE MINE



FACILE À UTILISER  
 ET À EFFACER

MODES  
 D'ÉCRITURE



CRAYON PC  
 HB Ø 2,3MM

TECHNIQUES  
 D'IMPRESSION



SÉRIGRAPHIE



DIGITAL

DURABILITÉ



ECOLUTIONS®



RÉFRIGÉRATEURS ET  
 DE POTS DE YAOURTS



LE PARTENARIAT  
 TERRACYCLE® PERMET  
 DE RECYCLER  
 LES INSTRUMENTS  
 D'ÉCRITURE BIC EN FRANCE

BIC  
 GRAPHIC

INSTRUMENTS  
 D'ÉCRITURE BIC®

AUTRES INSTRUMENTS  
 D'ÉCRITURE

CARNETS

BRIQUETS BIC®/DIEEP®  
 ET ÉTUIS BIC®

EMBALLAGES  
 BIC®

INFORMATIONS  
 GÉNÉRALES

Consultez la page 274-277 pour une explication détaillée des icônes

# BIC® KIDS EVOLUTION® COLOURING SET



Crayons sans bois ultra-résistants et faciles à tailler.  
Idéal pour le dessin et le coloriage au quotidien.



FABRIQUÉ À PARTIR DE  
51% DE MATÉRIEL RECYCLÉ\*

\*Hors plomb



RÉFRIGÉRATEURS  
ET DE POTS  
DE YAOURTS



Utilisation sûre  
pour les enfants

- Ne se casse pas en éclats
- Résistant à la mastication

1608

BIC® KIDS EVOLUTION® COLOURING SET  
eColutions® 1608

Portefeuille de carton  
entièrement personnalisable\*\*

NOUVEAU !



\* Le pourcentage est calculé sur la base du poids total du crayon, à l'exclusion de la mine.

\*\* Crayons non personnalisables

1608

**BIC® KIDS EVOLUTION® COLOURING SET**  
**ecolutions® 1608**

A DG: Numérique

Commande minimale 1200u.

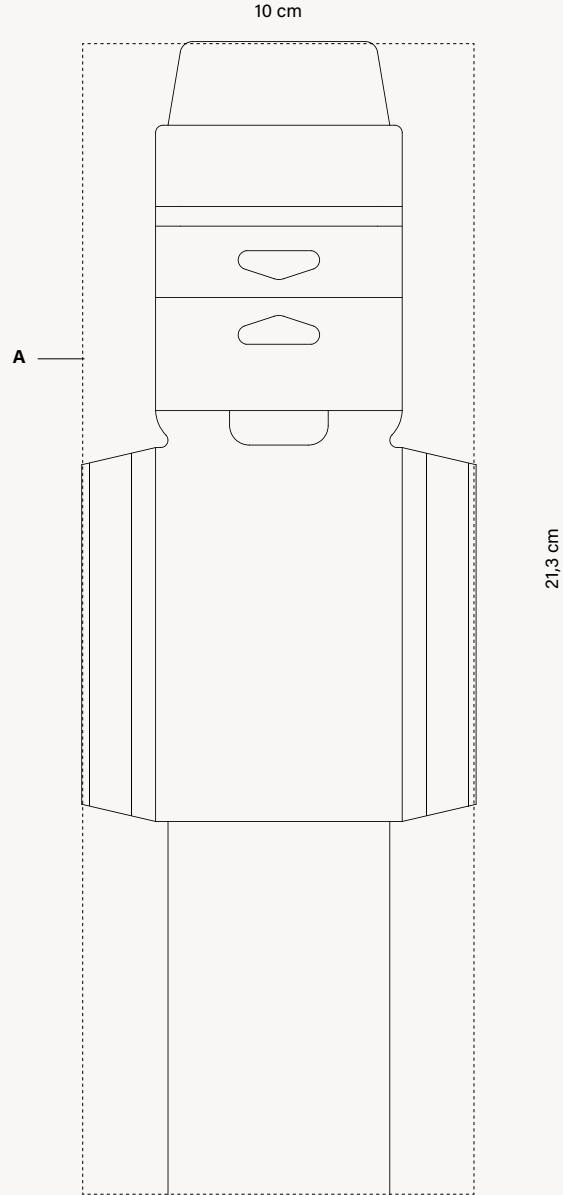

**Personnalisation**



FABRIQUÉ ET  
IMPRIMÉ DANS  
LES USINES BIC



FABRIQUÉ  
EN FRANCE



RESPECTANT  
LES NORMES



ISO  
certified



MINE RÉSISTANTE



PAS D'ÉCHARDES  
EN CAS DE BRISURE



PROTECTEUR  
DE MINE

**MODES  
D'ÉCRITURE**



CRAYONS  
Ø 3,05MM

**DURABILITÉ**



IMPRIM'VERT®

ecolutions®



RÉFRIGÉRATEURS ET  
DE POTS DE YAOURTS



LE PARTENARIAT  
TERRACYCLE® PERMET  
DE RECYCLER  
LES INSTRUMENTS  
D'ÉCRITURE BIC EN FRANCE

**EMBALLAGE EXTERNE**



500 ± 2,5 KG (SEULEMENT LE CRAYON)  
± 5 KG (AVEC EMBALLAGE CARDBOARD)

**EMBALLAGE**



FSC®  
FOREST  
STEWARDSHIP  
COUNCIL

Consultez la page 274-277 pour une explication détaillée des icônes



# SPROUT™ CRAYON GRAPHITE



Le crayon durable que vous pouvez planter après son utilisation et faire pousser des plantes, des légumes ou des fleurs.

53062

SPROUT™ CRAYON GRAPHITE  
53062

Avec des  
graines

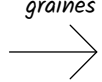

Corps standard



Corps personnalisés

Carton standard!

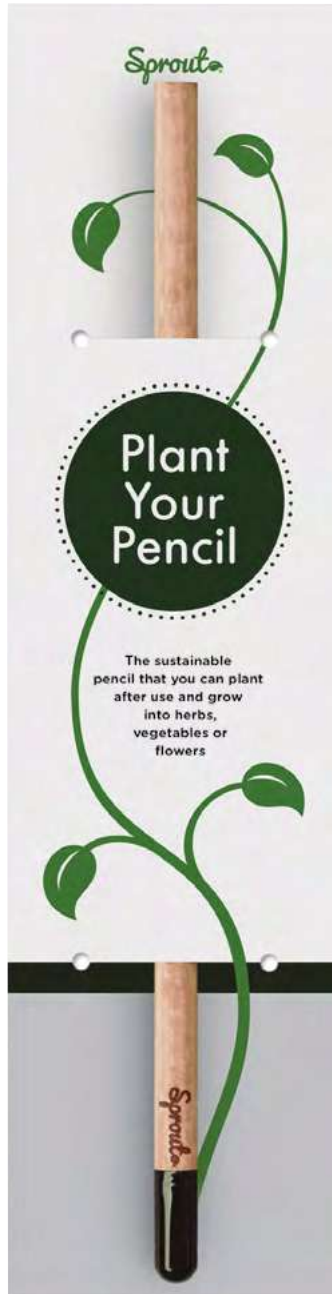

80%

Emballage carton standard

Carton personnalisable!



80%

Emballage carton personnalisé



Arrière



Mine graphite

Une fois que le crayon est trop court pour écrire, plantez-le et regardez votre message se transformer en superbe pot d'herbes aromatiques, de fleurs ou de légumes.

Choisissez entre 9 graines différentes!

NOUVEAU!



FRAISE



Épicéa



Tournesol



Marguerite



Sauge



Tomate cerise



Myrsotis



Basilic



Thym



Personnalisation

53062

**SPROUT™ CRAYON GRAPHITE**

53062

A LE  
B DG

Commande minimale 100 u.

*Un service de taille de crayons est proposé moyennant un supplément*

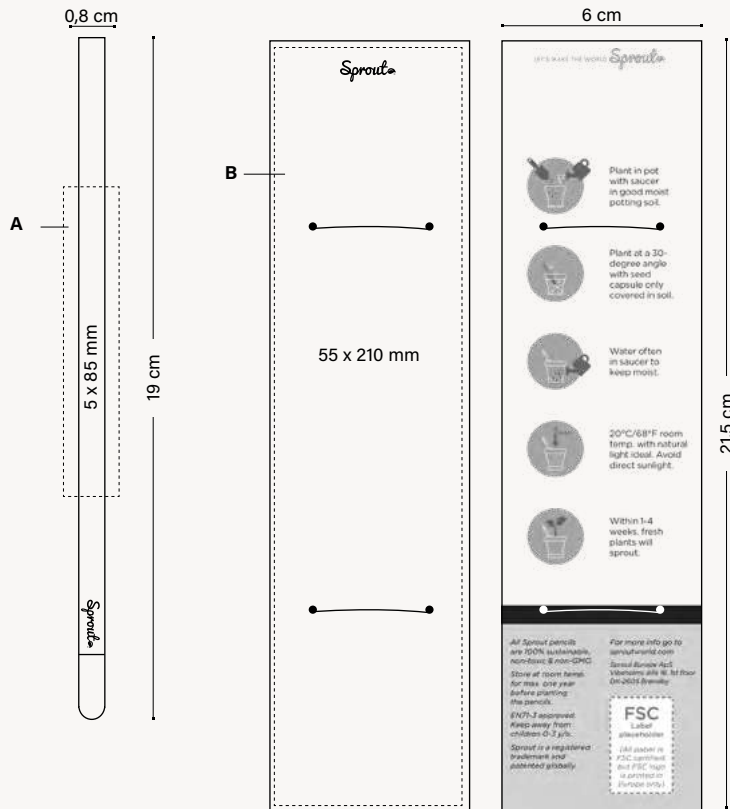

*Mode d'emploi inclus au dos. Pour un carton personnalisé, vous pouvez changer la police et les couleurs*

EMBALLAGE EXTERNE



500 ± 2,5 KG (SEULEMENT CRAYON)  
± 5 KG (AVEC EMBALLAGE EN CARTON)

EMBALLAGE



MODES D'ÉCRITURE



CRAYON PC HB  
Ø 2,3MM

TECHNIQUES D'IMPRESSION



LASER



DIGITAL

DURABILITÉ



FSC ET CARTON RECYCLABLE



LE PARTENARIAT TERRACYCLE™ PERMET DE RECYCLER LES INSTRUMENTS D'ÉCRITURE BIC EN FRANCE



REGARDEZ LA VIDEO

Consultez la page 274-277 pour une explication détaillée des icônes

BIC GRAPHIC

INSTRUMENTS D'ÉCRITURE BIC®

AUTRES INSTRUMENTS D'ÉCRITURE

CARNETS

BRIQUETS BIC®/DIEEP® ET ÉTUIS BIC®

EMBALLAGES BIC®

INFORMATIONS GÉNÉRALES

Index

# AUTRES INSTRUMENTS D'ÉCRITURE

---

# 02

---

**STYLOS EN PLASTIQUE**

Basic Pen	190
Click Pen	192
Striped Grip Pen	194

**STYLOS AVEC STYLET**

Sleek Stylus Pen	196
------------------	-----

# BASIC PEN

---

12010

**BASIC PEN**

12010

Couleur d'encre



## Personnalisation

12010

**BASIC PEN**  
12010

A/B SP: max. 1 col.

Commande minimale 500 u.

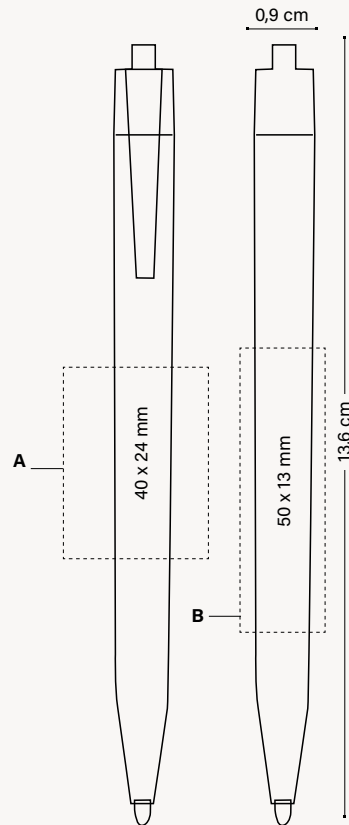

## EMBALLAGE EXTERNE



1000 ± 12,5 KG



MODES D'ÉCRITURE



TECHNIQUES D'IMPRESSION



DURABILITÉ



BIC  
GRAPHIC

INSTRUMENTS  
D'ÉCRITURE BIC®

AUTRES INSTRUMENTS  
D'ÉCRITURE

CARNETS

BRIQUETS BIC®/DIEEP®  
ET ÉTUIS BIC®

EMBALLAGES  
BIC®

INFORMATIONS  
GÉNÉRALES

Consultez la page 274-277 pour une explication détaillée des icônes

# CLICK PEN

---

11748

**CLICK PEN**

11748

Couleur d'encre



11748

**CLICK PEN**

11748

**A/B SP:** max. 4 col.

**C/D PD:** max. 4 col.

Commande minimale 500 u.

**Personnalisation**

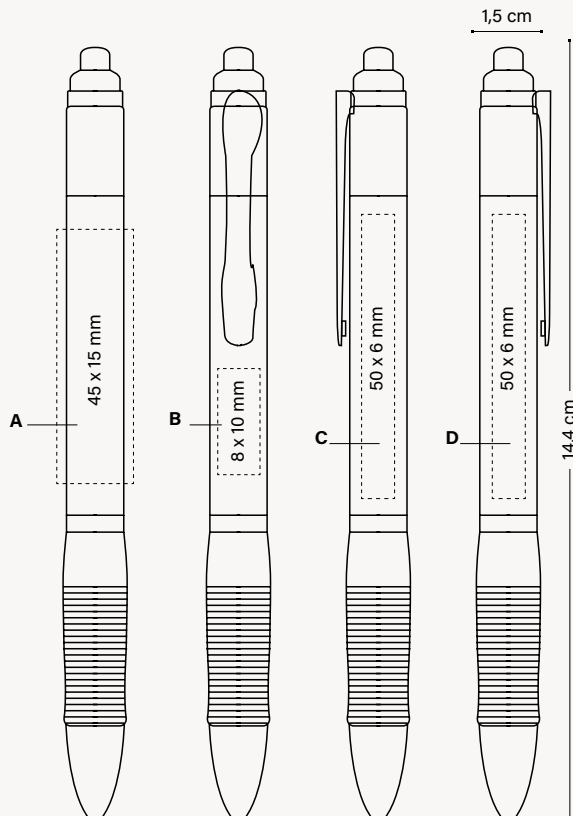

**EMBALLAGE EXTERNE**



1000 ± 9,5 KG



**MODES D'ÉCRITURE**



**TECHNIQUES D'IMPRESSION**



**DURABILITÉ**



BIC GRAPHIC

INSTRUMENTS D'ÉCRITURE BIC®

AUTRES INSTRUMENTS D'ÉCRITURE

CARNETS

BRIQUETS BIC®/DIEEP® ET ÉTUIS BIC®

EMBALLAGES BIC®

INFORMATIONS GÉNÉRALES

Consultez la page 274-277 pour une explication détaillée des icônes



# STRIPED GRIP PEN

---

11243

## STRIPED GRIP PEN

11243

Couleur d'encre



10



03



24



8C



04

100%

11243

### STRIPED GRIP PEN

11243

**A SP:** max. 2 col.

**B PD:** max. 1 col.

Commande minimale 500 u.

### Personnalisation

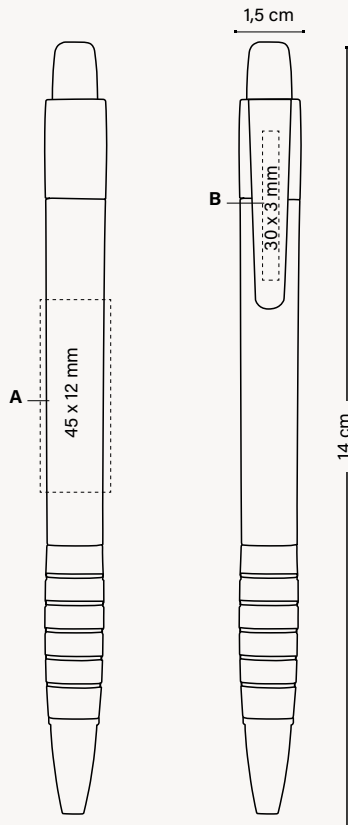

### EMBALLAGE EXTERNE



1000 ± 9 KG



### MODES D'ÉCRITURE



### TECHNIQUES D'IMPRESSION



### DURABILITÉ



BIC  
GRAPHIC

INSTRUMENTS  
D'ÉCRITURE BIC®

AUTRES INSTRUMENTS  
D'ÉCRITURE

CARNETS

BRIQUETS BIC®/DIEEP®  
ET ÉTUIS BIC®

EMBALLAGES  
BIC®

INFORMATIONS  
GÉNÉRALES

Consultez la page 274-277 pour une explication détaillée des icônes

# SLEEK STYLUS PEN

---

11666

## SLEEK STYLUS PEN

11666

Couleur d'encre



01

100%

11747

## SLEEK STYLUS MATT PEN

11747

Couleur d'encre



47



04

100%

11976

## SLEEK STYLUS EXECUTIVE PEN

11976



26

●  
Disponible en  
encre bleue



2N

●  
Disponible en  
encre noire

100%

## Personnalisation

11666 / 11747 / 11976

### SLEEK STYLUS PEN

11666

### SLEEK STYLUS MATT PEN

11747

### SLEEK STYLUS EXECUTIVE PEN

11976

**A SP:** max. 1 col.

**B SP:** max. 2 col.

**C LE**

Commande minimale 500 u. (SP)

Commande minimale 100 u. (LE)

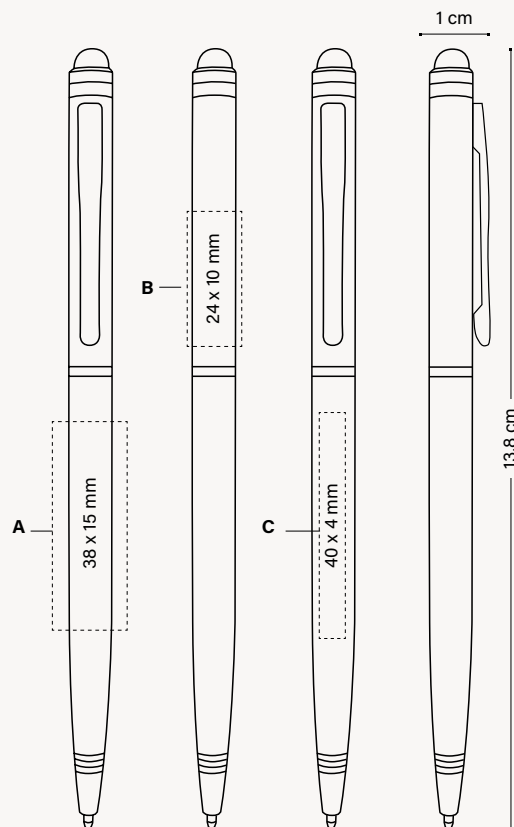

## EMBALLAGE EXTERNE



(11666)  
900 ± 12,4 KG



(11747 / 11976)  
800 ± 13 KG



## MODES D'ÉCRITURE



## TECHNIQUES D'IMPRESSION



## DURABILITÉ



BIC  
GRAPHIC

INSTRUMENTS  
D'ÉCRITURE BIC®

AUTRES INSTRUMENTS  
D'ÉCRITURE

CARNETS

BRIQUETS BIC®/DIEEP®  
ET ÉTUIS BIC®

EMBALLAGES  
BIC®

INFORMATIONS  
GÉNÉRALES

Consultez la page 274-277 pour une explication détaillée des icônes

Index

# CARNETS

---

# 03

---

**ROCKETBOOK®**

Rocketbook® Core Executive A5	202
Rocketbook® Fusion Executive A5	204
Rocketbook® Core Mini A6	206

**MOLESKINE**

Carnet de notes Moleskine® Classic	210
Moleskine Cahier Journals	214

# ROCKETBOOK®

**Rocketbook® combine l'avantage d'un stylo traditionnel avec un carnet et une application pour envoyer des notes écrites à la main de manière rapide et sécurisée au fichier cloud de votre choix. Suivez les instructions indiquées pour effacer vos notes afin de pouvoir réutiliser immédiatement votre carnet. Vous avez le choix entre le modèle Core pour prendre des notes, réaliser des graphiques, des croquis... ou passez au modèle supérieur avec le Fusion pour planifier, lister ou organiser vos objectifs.**



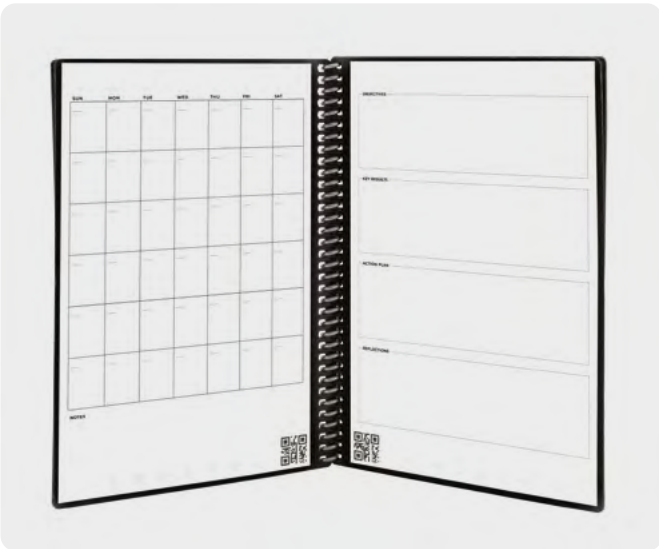

**ROCKETBOOK® CORE EXECUTIVE A5**  
**ROCKETBOOK® FUSION EXECUTIVE A5**  
**ROCKETBOOK® CORE MINI A6**



NOUVEAU !

NOUVELLE COMMANDE MINIMALE  
AMÉLIORÉE 25 UNITÉS !

3728

ROCKETBOOK® CORE EXECUTIVE A5  
3728



07  
●  
Couleur  
bleu nuit



01  
○  
Couleur  
blanc



02  
●  
Couleur  
noir

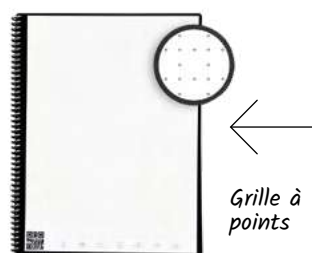
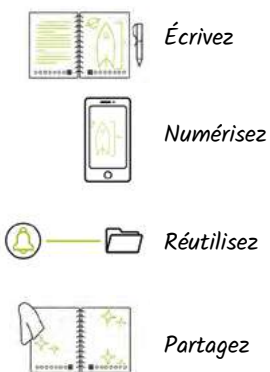

La boîte inclut toujours :  
- Carnet  
- Stylo  
- Chiffon  
- Instructions

## Personnalisation

3728

### ROCKETBOOK® CORE EXECUTIVE A5

3728

**A SP:** max. 1 col.

**B BP:** Numérique

**C HS:** max. 1 col.

36 pages

Commande minimale 25 u.

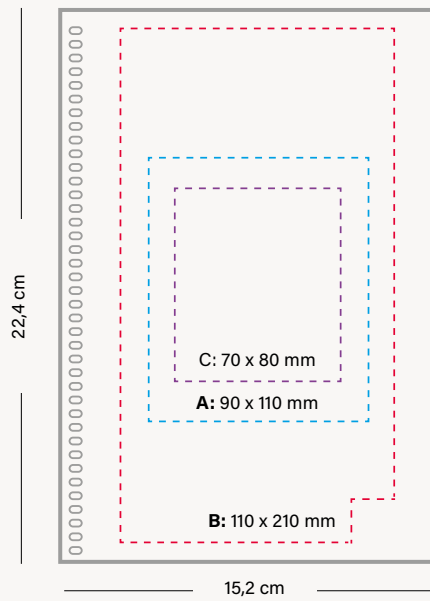

#### EMBALLAGE SPÉCIAL TOUJOURS INCLUS



GIFT BOX  
CORE A5

#### EMBALLAGE EXTERNE



50 ± 5,8 KG



#### TECHNIQUES D'IMPRESSION



#### DURABILITÉ



TÉLÉCHARGEZ LA APP



TÉLÉCHARGEZ LA APP



COMMENT CELA FONCTIONNE ?

Consultez les pages 274-277 pour une explication détaillée des icônes.

BIC  
GRAPHIC

INSTRUMENTS  
D'ÉCRITURE BIC®

AUTRES INSTRUMENTS  
D'ÉCRITURE

CARNETS

BRIQUETS BIC®/DIEEP®  
ET ÉTUIS BIC®

EMBALLAGES  
BIC®

INFORMATIONS  
GÉNÉRALES

3726

NOUVELLE COMMANDE MINIMALE AMÉLIORÉE 25 UNITÉS !

ROCKETBOOK® FUSION EXECUTIVE A5  
3726



01  
○  
Couleur blanc



02  
●  
Couleur noir

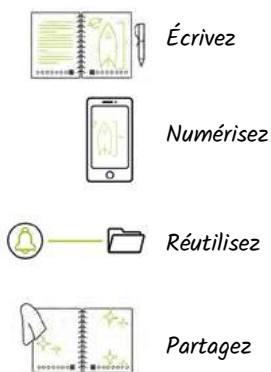

7 styles de pages

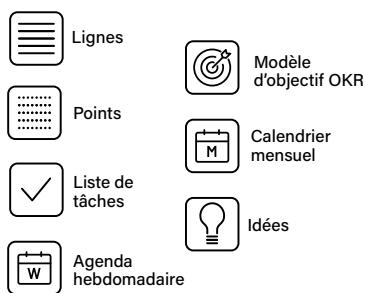

Votre marquage visible grâce à la fenêtre de la boîte cadeau



La boîte inclut toujours :  
- Carnet  
- Stylo  
- Chiffon  
- Instructions

## Personnalisation

3726

### ROCKETBOOK® FUSION EXECUTIVE A5

3726

**A SP:** max. 1 col.

**B BP:** Numérique

**C HS:** max. 1 col.

42 pages

Commande minimale 25 u.

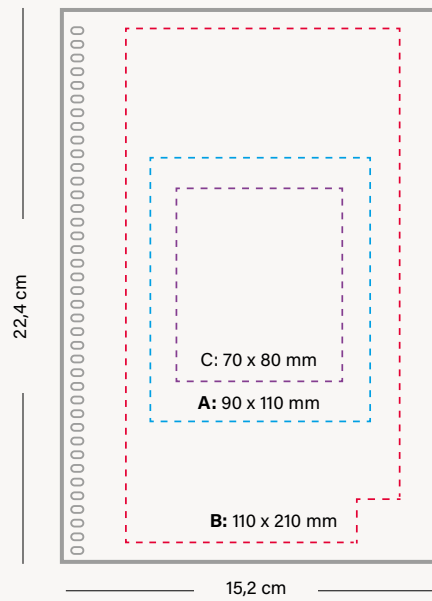

#### EMBALLAGE SPÉCIAL TOUJOURS INCLUS



GIFT BOX  
FUSION A5

#### EMBALLAGE EXTERNE



50 ± 5,8 KG



IMPRIMÉ DANS  
LES USINES BIC



RESPECTANT  
LES NORMES

#### TECHNIQUES D'IMPRESSION



SP  
SÉRIGRAPHIE



BP  
BRITPEPIX™



HS  
HOT STAMPING

#### DURABILITÉ



IMPRIM'VERT®



TÉLÉCHARGEZ LA APP



TÉLÉCHARGEZ LA APP



COMMENT CELA  
FONCTIONNE ?

Consultez les pages 274-277 pour une explication détaillée des icônes.

BIC  
GRAPHIC

INSTRUMENTS  
D'ÉCRITURE BIC®

AUTRES INSTRUMENTS  
D'ÉCRITURE

CARNETS

BRIQUETS BIC®/DIEEP®  
ET ÉTUIS BIC®

EMBALLAGES  
BIC®

INFORMATIONS  
GÉNÉRALES

3727

NOUVELLE COMMANDE MINIMALE  
AMÉLIORÉE 25 UNITÉS !

ROCKETBOOK® CORE MINI A6  
3727



01  
○  
Couleur  
blanc



02  
●  
Couleur  
noir

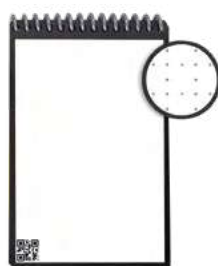
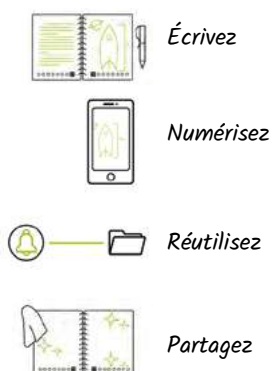

←  
Grille à  
points



←  
Votre marquage visible  
grâce à la fenêtre de  
la boîte cadeau

- La boîte inclut toujours :
- Carnet
  - Stylo
  - Chiffon
  - Instructions

## Personnalisation

3727

### ROCKETBOOK® CORE MINI A6

3727

**A SP:** max. 1 col.

**B BP:** Numérique

**C HS:** max. 1 col.

48 pages

Commande minimale 25 u.

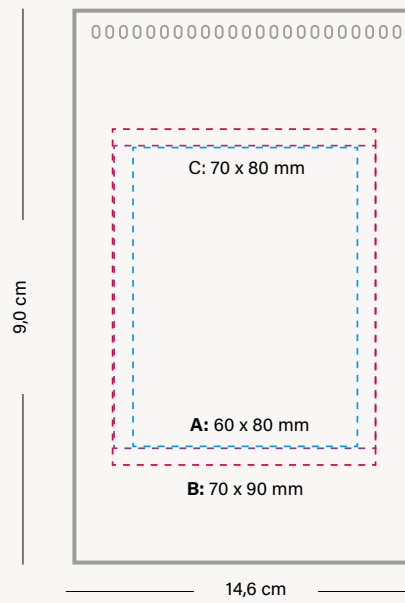

#### EMBALLAGE SPÉCIAL TOUJOURS INCLUS



GIFT BOX  
CORE A6

#### EMBALLAGE EXTERNE



50 ± 2,6 KG



#### TECHNIQUES D'IMPRESSION



#### DURABILITÉ



TÉLÉCHARGEZ LA APP



TÉLÉCHARGEZ LA APP



COMMENT CELA  
FONCTIONNE ?

Consultez les pages 274-277 pour une explication détaillée des icônes.

BIC  
GRAPHIC

INSTRUMENTS  
D'ÉCRITURE BIC®

AUTRES INSTRUMENTS  
D'ÉCRITURE

CARNETS

BRIQUETS BIC®/DIEEP®  
ET ÉTUIS BIC®

EMBALLAGES  
BIC®

INFORMATIONS  
GÉNÉRALES



---

MOLESKINE®

**Plus qu'un carnet, c'est  
une expérience**

**M  MOLESKINE**



**Designs classiques et sophistiqués.**

**Matériaux et finitions de haute qualité.**

**Sérigraphie, marquage à chaud et gaufrage.**

**Le bandeau peut être personnalisé par impression numérique.**

**Options de personnalisation avec des logos et des dessins sur les couvertures et les pages intérieures.**



15056

**CARNET DE NOTES MOLESKINE® CLASSIC**  
**LARGE 13 X 21 CM**  
**COUVERTURE RIGIDE**  
15056

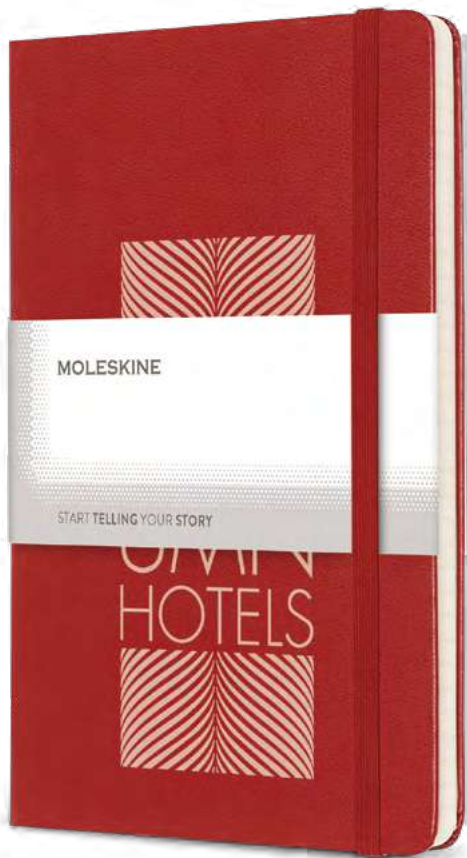

## COUVERTURE RIGIDE !

- Couverture rigide de couleur
- Coins arrondis, fermeture élastique et signet en ruban.
- Poche intérieure extensible au dos.
- Reste complètement ouvert à 180°.
- Les pages lignées ou unies et d'autres mises en page sont disponibles sur demande. Papier de couleur ivoire, sans acide, 70 g/m2.
- Une vaste gamme de couleurs, de présentations et de formats.
- Des designs classiques et sophistiqués.
- Des options de personnalisation pour les logos et les dessins sur les couvertures et les pages intérieures.
- Sérigraphie, marquage à chaud et gaufrage. Le bandeau peut être personnalisé par impression numérique.

15056

CARNET DE NOTES MOLESKINE® CLASSIC  
15056 (Couverture rigide grand format)

PAGES INTÉRIURES :  
240: 15056  
Papier ivoire 70 g/m<sup>2</sup>

- A SP: maxi. 1 col.
- B DB : transparent
- C BP : BritePix™
- D DG : bandeau : numérique
- E HS : máx. 1 col.

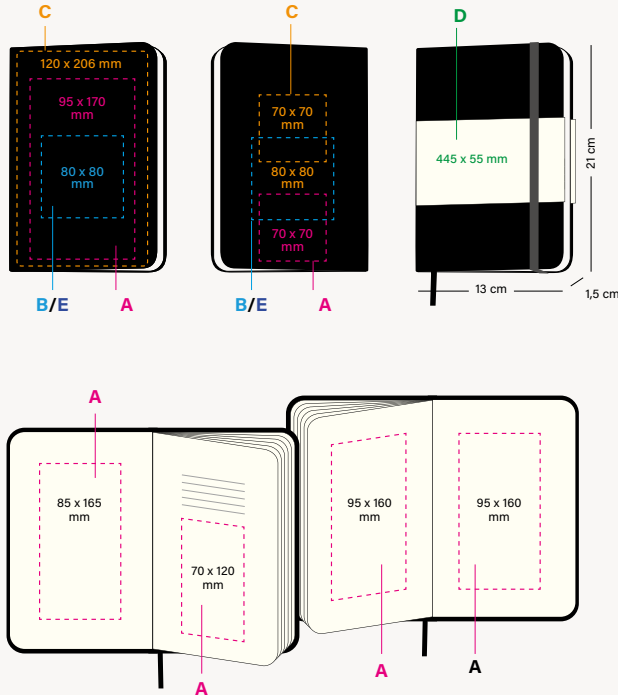

TECHNIQUES D'IMPRESSION



DURABILITÉ



15056 COUVERTURE RIGIDE



PAPIER LIGNÉ

- |                 |               |                          |                    |               |
|-----------------|---------------|--------------------------|--------------------|---------------|
| ● Black         | ● Slate Grey  | DISPONIBLE SUR DEMANDE : |                    | ● Reef Blue   |
| ● Sapphire Blue | ● Scarlet Red | ● Lemon Green            | ● Amaranth Red     | ● Earth Brown |
| ● Prussian Blue | ○ White       | ● Citron Yellow          | ● Coral Orange     | ● Daisy Pink  |
|                 |               | ● Willow Green           | ● Orange Yellow    |               |
|                 |               | ● Oxide Green            | ● Brilliant Violet |               |
|                 |               | ● Myrtle Green           | ■ PAPIER QUADRILLÉ |               |

15056 COUVERTURE RIGIDE



PAPIER LIGNÉ

- |                 |                |
|-----------------|----------------|
| ● Black         | ● Reef Blue    |
| ● Sapphire blue | ● Earth Brown  |
| ● Scarlet Red   | ● Myrtle Green |

15065

**CARNET DE NOTES MOLESKINE® CLASSIC**  
**LARGE 13 X 21 CM**  
**COUVERTURE SOUPLE**  
15065

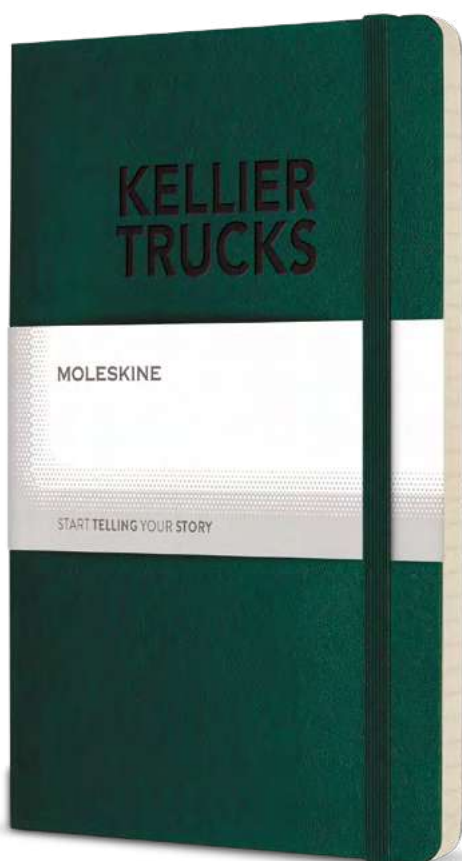

## COUVERTURE SOUPLE !

- Couverture souple de couleur
- Coins arrondis, fermeture élastique et signet en ruban.
- Poche intérieure extensible au dos.
- Reste complètement ouvert à 180°.
- Les pages lignées ou unies et d'autres mises en page sont disponibles sur demande. Papier de couleur ivoire, sans acide, 70 g/m<sup>2</sup>.
- Une vaste gamme de couleurs, de présentations et de formats.
- Des designs classiques et sophistiqués.
- Des options de personnalisation pour les logos et les dessins sur les couvertures et les pages intérieures.
- Sérigraphie, marquage à chaud et gaufrage. Le bandeau peut être personnalisé par impression numérique.

Personnalisation

15065







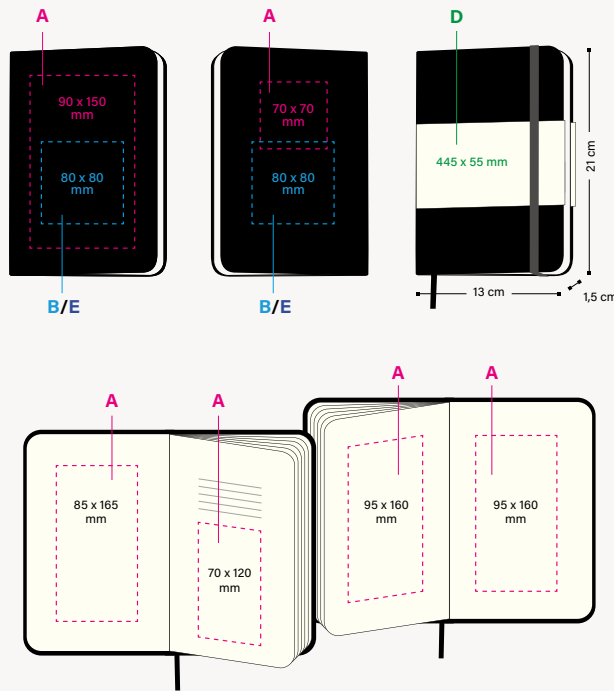

CARNET DE NOTES MOLESKINE® CLASSIC  
15065 (Couverture souple grand format)

PAGES INTÉRIURES :  
192: 15065  
Papier ivoire 70 g/m<sup>2</sup>



- A SP: maxi. 1 col.
- B DB: transparent
- C BP: BritePix™
- D DG: bandeau: numérique
- E HS: máx. 1 col.



15065 COUVERTURE SOUPLE  PAPIER LIGNÉ

- |   |  |
|---|--|
|  Black         | DISPONIBLE SUR DEMANDE :   |
|  Sapphire blue |  Reef Blue        |
|  Scarlet Red   |  Underwater Blue  |
|   |  Earth Brown      |
|   |  PAPIER QUADRILLÉ |
|   |  PAPIER POINTILLÉ |

15065 COUVERTURE SOUPLE  PLAIN PAPER

- |   |   |
|---|---|
|  Black         | DISPONIBLE SUR DEMANDE :  |
|  Sapphire blue |  Scarlet Red   |
|   |  Prussian Blue |



TECHNIQUES D'IMPRESSION



DURABILITÉ



BIC GRAPHIC

INSTRUMENTS D'ÉCRITURE BIC®

AUTRES INSTRUMENTS D'ÉCRITURE

CARNETS

BRIOUETS BIC®/DIEEP® ET ÉTUIS BIC®

EMBALLAGES BIC®

INFORMATIONS GÉNÉRALES

Consultez les pages 274-277 pour une explication détaillée des icônes.



15076 / 15067

MOLESKINE® CAHIER JOURNALS  
15076 / 15067

---



Black

Kraft Brown

**Pratiques, personnalisables et résistants. Les carnets Moleskine® Cahier Journals, vos meilleurs compagnons de voyage, présentent les caractéristiques suivantes:**

- Couverture résistante, personnalisable et souple avec reliure visible sur le dos
- Les 16 dernières pages sont détachables.



15076 / 15067

MOLESKINE® CAHIER JOURNALS

15076 / 15067

A SP : max. 1 col.

B HS : max. 1 col.

C DB: transparent

PAGES INTÉRIÈRES :

64: 15076

80 : 15067

Papier couleur ivoire , 70 g/m<sup>2</sup>

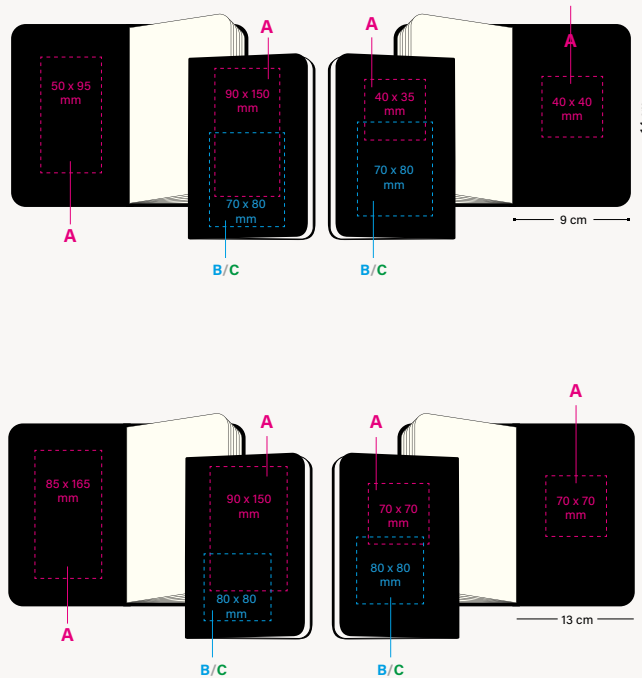

15067 LARGE

PAPIER À LIGNES

Black Indigo Blue

Kraft Brown

DISPONIBLE SUR DEMANDE :

Cranberry Red Pebble Grey

PLAIN PAPER

15067 LARGE

PAPIER À LIGNES PLAIN PAPER

Cranberry Red Indigo Blue

15076 POCKET

PAPIER À LIGNES

Black

DISPONIBLE SUR DEMANDE :

Kraft Brown

Indigo Blue

PLAIN PAPER



TECHNIQUES D'IMPRESSION



SÉRIGRAPHIE



HOT STAMPING



DEBOSSING

DURABILITÉ



**BRIQUETS  
BIC® / DJEEP®  
ET ÉTUIS BIC®**

---

**04**

---

**BIC® BRIQUETS**

BIC® J25 Briquet	222
BIC® J23 Briquet	226
BIC® J26 Briquet	230
BIC® J38 Briquet	234

**BIC® ÉTUIS**

BIC® Styl'it Luxury Étui	238
BIC® Aluminium Flat Étui	240
BIC® Clip Étui	241
BIC® 3D Étui	242

**AUTRES PRODUITS**

BIC® EZ Reach™	244
BIC® Cendrier de poche	248

**DJEEP® BRIQUETS**

DJEEP® D1 Briquet	250
-------------------	-----

# Briquets BIC®

## Notre qualité. Votre sécurité.

Tous les briquets BIC® respectent ou dépassent les exigences des normes et réglementations internationales (ISO 9994, EN 13869, ASTM F400, US CPSC).



**BIC® est le numéro un mondial des briquets de marque.\***



**100% des briquets sont fabriqués par BIC® en Europe. Tous les briquets BIC® sont fabriqués dans les usines de BIC. C'est le point de départ de la garantie de sécurité des briquets BIC®.**

**50 ANS**

**BIC® a acquis 50 ans d'une incroyable expertise de fabrication afin de garantir la sécurité et la qualité de ses produits.**

**50 CONTRÔLES**

**Avant de quitter l'usine, chaque briquet BIC® subit plus de 50 contrôles automatiques de qualité et de sécurité.**

**CHOISISSEZ BIEN ! Les briquets de poche BIC®**



**BIC® J25  
Briquet**

 JUSQU'À  
1450



**BIC® J23  
Briquet**

 JUSQU'À  
1800



**BIC® J26  
Briquet**

 JUSQU'À  
3000



**BIC® J38  
Briquet**

 JUSQU'À  
1800

# BRIQUETS BIC®



**Le célèbre briquet BIC®, une icône indémodable,  
avec un design toujours tendance !**

**4 tailles différentes et une vaste gamme de  
combinaisons de couleurs.**



- BIC® J25 BRIQUET**
- BIC® J23 BRIQUET**
- BIC® J26 BRIQUET**
- BIC® J38 BRIQUET**
- BIC® STYL'IT LUXURY ÉTUI**
- BIC® ALUMINIUM FLAT ÉTUI**
- BIC® CLIP ÉTUI**
- BIC® 3D ÉTUI**
- BIC® CENDRIER DE POCHE**





# BIC® J25 BRIQUET

## Parfait pour votre poche

2360 / 2364



*l'icône BIC® Boy  
et le logo BIC® gravé !*

### BIC® J25 BRIQUET

2360

2364 All Black



01

57

57

8G

03

11

59

24

04



25

25

6W

90

02

02

02

02

100%

Personnalisation

2360/2364

**BIC® J25 BRIQUET**

2360/2364

A/C SP: max. 4 col.

Commande minimale 300 u.

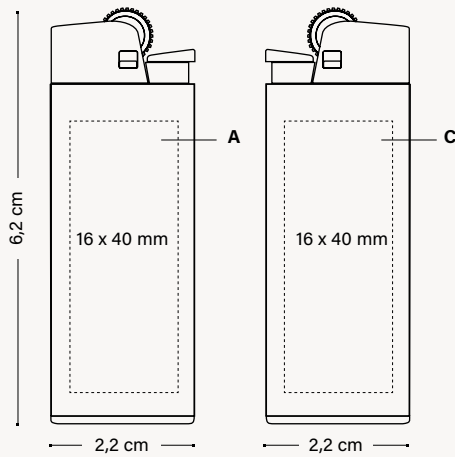

2360/2364

**BIC® J25 BRIQUET BRITEPIX™**

2360 / 2364

A/C BP: Numérique

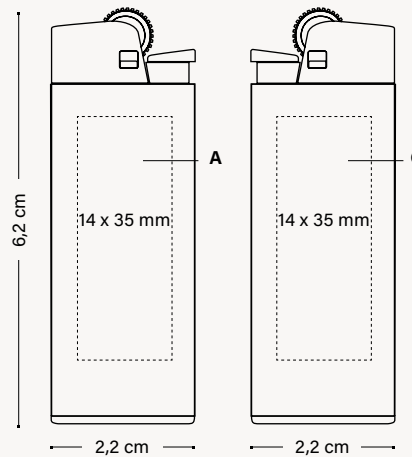

EMBALLAGE



100% recyclé !

EMBALLAGE STANDARD :  
BARQUETTE DE 50 U.

EMBALLAGE EXTERNE



600 ± 76 KG



FSC ET CARTON  
RECYCLABLE



TECHNIQUES  
D'IMPRESSION



DURABILITÉ



Consultez les pages 274-277 pour une explication détaillée des icônes.

BIC  
GRAPHIC

INSTRUMENTS  
D'ÉCRITURE BIC®

AUTRES INSTRUMENTS  
D'ÉCRITURE

CARNETS

BRIQUETS BIC®/DIEEP®  
ET ÉTUIS BIC®

EMBALLAGES  
BIC®

INFORMATIONS  
GÉNÉRALES

FINITIONS NUMÉRIQUES



**BR** BRILLIANT



**MT** MATT

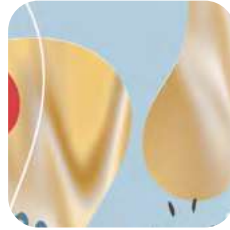

**H** HOLOGRAPHIC SILVER GOLD



**P** PUFFY



**M** METALLIC



**UV** UV



**PG** PUFFY GLITTER

2360

BIC® J25 BRIQUET DIGITAL  
2360



**MT** MATT

**P** PUFFY



**PG** PUFFY GLITTER



**MT** MATT

**M** METALLIC

## Personnalisation

2360

**BIC® J25 BRIQUET DIGITAL**

2360

**A DG:** Numérique

Commande minimale 600 u.

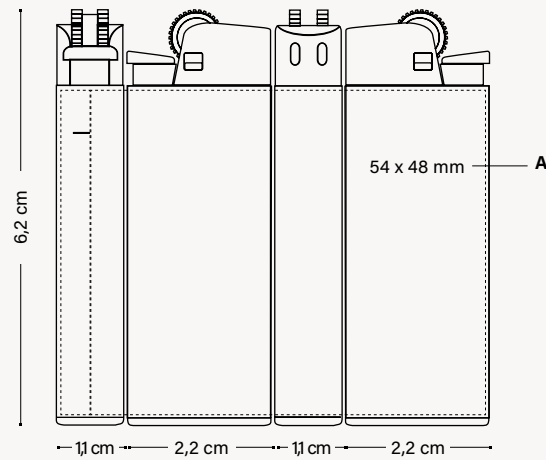

### EMBALLAGE



100% recyclé !

EMBALLAGE STANDARD :  
BARQUETTE DE 50 U.

### EMBALLAGE EXTERNE



600 ± 76 KG



FSC ET CARTON  
RECYCLABLE

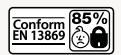

TECHNIQUES  
D'IMPRESSION



DURABILITÉ



100 % DE L'ÉLECTRICITÉ  
PROVIENT DE SOURCES  
RENOUVELABLES

BIC  
GRAPHIC

INSTRUMENTS  
D'ÉCRITURE BIC®

AUTRES INSTRUMENTS  
D'ÉCRITURE

CARNETS

BRIQUETS BIC®/DIEEP®  
ET ÉTUIS BIC®

EMBALLAGES  
BIC®

INFORMATIONS  
GÉNÉRALES

Consultez les pages 274-277 pour une explication détaillée des icônes.



*l'icône BIC® Boy  
et le logo BIC® gravé !*

2340

**BIC® J23 BRIQUET**  
2340



57



12



03



10

*Fin et élégant,  
il se glisse partout !*



05



04



25



02

Personnalisation

2340

**BIC® J23 BRIQUET**

2340

A/C SP: max. 4 col.

Commande minimale 300 u.

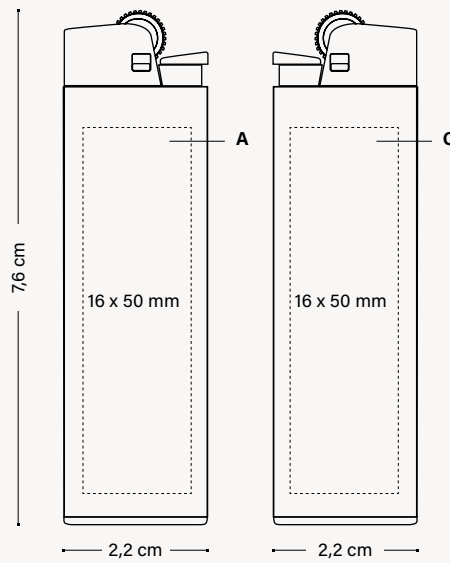

TECHNIQUES D'IMPRESSION



DURABILITÉ



EMBALLAGE



100% recyclé !

EMBALLAGE STANDARD :  
BARQUETTE DE 50 U.

EMBALLAGE EXTERNE



600 ± 9,5 KG



FSC ET CARTON  
RECYCLABLE

Consultez les pages 274-277 pour une explication détaillée des icônes.

BIC  
GRAPHIC

INSTRUMENTS  
D'ÉCRITURE BIC®

AUTRES INSTRUMENTS  
D'ÉCRITURE

CARNETS

BRIQUETS BIC®/DIEEP®  
ET ÉTUIS BIC®

EMBALLAGES  
BIC®

INFORMATIONS  
GÉNÉRALES

FINITIONS NUMÉRIQUES



**BR** BRILLIANT



**MT** MATT

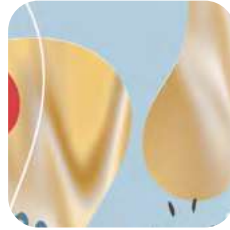

**H** HOLOGRAPHIC SILVER GOLD



**P** PUFFY



**M** METALLIC



**UV** UV



**PG** PUFFY GLITTER

2340

BIC® J23 BRIQUET DIGITAL  
2340



**MT** MATT



**PG** PUFFY GLITTER



**BR** BRILLIANT

**H** HOLOGRAPHIC GOLD

impression  
360°

100%



2340

**BIC® J23 BRIQUET DIGITAL**

2340

**A DG:** Numérique

Commande minimale 600 u.

**Personnalisation**



**TECHNIQUES D'IMPRESSION**

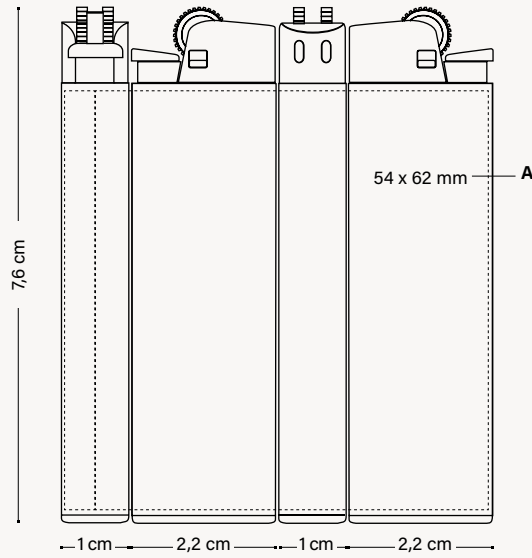

**EMBALLAGE**



100% recyclé !

EMBALLAGE STANDARD :  
BARQUETTE DE 50 U.

**EMBALLAGE EXTERNE**



600 ± 9,5 KG



FSC ET CARTON  
RECYCLABLE

Consultez les pages 274-277 pour une explication détaillée des icônes.

BIC  
GRAPHIC

INSTRUMENTS  
D'ÉCRITURE BIC®

AUTRES INSTRUMENTS  
D'ÉCRITURE

CARNETS

BRIQUETS BIC®/DIEEP®  
ET ÉTUIS BIC®

EMBALLAGES  
BIC®

INFORMATIONS  
GÉNÉRALES

# BIC® J26 BRIQUET

## La flamme qui dure.



l'icône BIC® Boy  
et le logo BIC® gravé !

2320

BIC® J26 BRIQUET  
2320



01



57



8G



10



6W

Longue durée:  
jusqu'à 3.000  
allumages !



59



24



25



02



03

Personnalisation

2320

**BIC® J26 BRIQUET**

2320

A/C SP: max. 4 col.

Commande minimale 300 u.

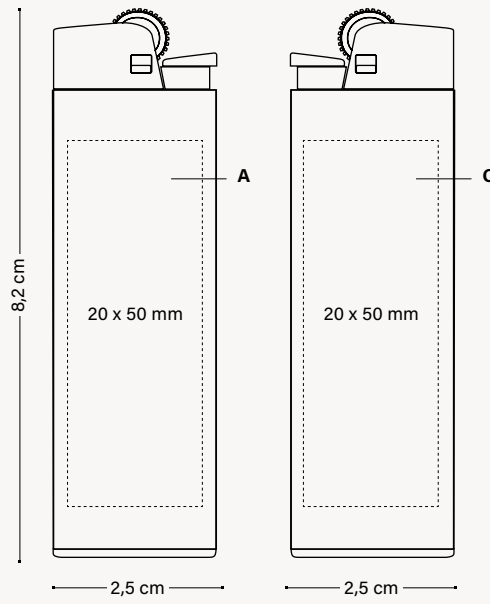

FABRIQUÉ ET IMPRIMÉ DANS LES USINES BIC



FABRIQUÉ EN ESPAGNE



RESPECTANT LES NORMES



JUSQU'À 3.000



TECHNIQUES D'IMPRESSION



SÉRIGRAPHIE

DURABILITÉ



100 % DE L'ÉLECTRICITÉ PROVIENT DE SOURCES RENOUVELABLES

EMBALLAGE



100% recyclé !

EMBALLAGE STANDARD : BARQUETTE DE 50 U.

EMBALLAGE EXTERNE



600 ± 15,1 KG



FSC ET CARTON RECYCLABLE

Consultez les pages 274-277 pour une explication détaillée des icônes.

BIC GRAPHIC

INSTRUMENTS D'ÉCRITURE BIC®

AUTRES INSTRUMENTS D'ÉCRITURE

CARNETS

BRIQUETS BIC®/DIEEP® ET ÉTUIS BIC®

EMBALLAGES BIC®

INFORMATIONS GÉNÉRALES

FINITIONS NUMÉRIQUES



**BR** BRILLIANT



**MT** MATT

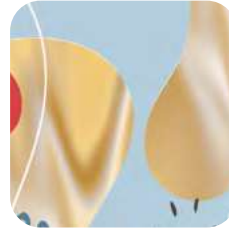

**H** HOLOGRAPHIC SILVER GOLD



**P** PUFFY



**M** METALLIC



**UV** UV



**PG** PUFFY GLITTER

2320

BIC® J26 BRIQUET DIGITAL  
2320



**MT** MATT

**H** HOLOGRAPHIC SILVER



**BR** BRILLIANT



impression  
360 °

**MT** MATT

100%

## Personnalisation

2320

### BIC® J26 BRIQUET DIGITAL

2320

A DG: Numérique

Commande minimale 600 u.

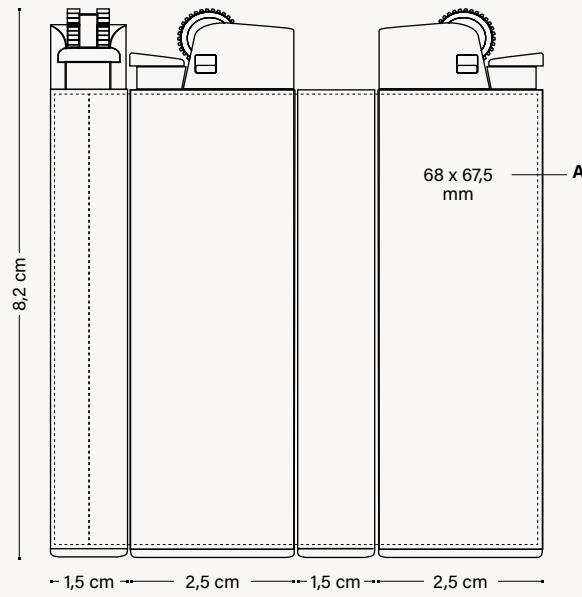

FABRIQUÉ ET  
IMPRIMÉ DANS  
LES USINES BIC



FABRIQUÉ  
EN ESPAGNE



RESPECTANT  
LES NORMES



JUSQU'À 3.000



Conform  
ISO 9994



Conform  
EN 13869 85%

TECHNIQUES  
D'IMPRESSION



DG  
DIGITAL

DURABILITÉ



100 % DE L'ÉLECTRICITÉ  
PROVIENT DE SOURCES  
RENOUVELABLES

### EMBALLAGE



100% recyclé !

EMBALLAGE STANDARD :  
BARQUETTE DE 50 U.

### EMBALLAGE EXTERNE



600 ± 15,1 KG



FSC ET CARTON  
RECYCLABLE

# BIC® J38 BRIQUET

---

2452



*l'iconique BIC® Boy et  
le logo BIC® gravé!*

**BIC® J38 BRIQUET**  
2452



57



25



02



03

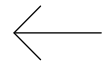

*Allumage  
confortable !*

100%

Personnalisation

2452

**BIC® J38 BRIQUET**

2452

A/C SP: max. 4 col.

Commande minimale 300 u.

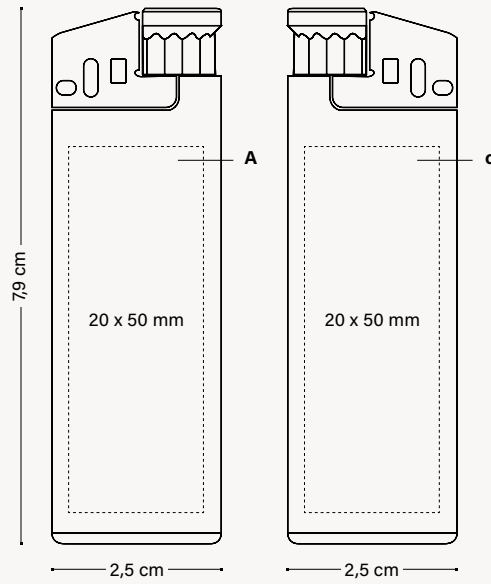

TECHNIQUES D'IMPRESSION



DURABILITÉ



**EMBALLAGE**



100% recyclé !

EMBALLAGE STANDARD : BARQUETTE DE 50 U.

**EMBALLAGE EXTERNE**



600 ± 13,2 KG



FSC ET CARTON RECYCLABLE

Consultez les pages 274-277 pour une explication détaillée des icônes.

BIC GRAPHIC

INSTRUMENTS D'ÉCRITURE BIC®

AUTRES INSTRUMENTS D'ÉCRITURE

CARNETS

BRIQUETS BIC®/DIEEP® ET ÉTUIS BIC®

EMBALLAGES BIC®

INFORMATIONS GÉNÉRALES



FINITIONS NUMÉRIQUES



**BR** BRILLIANT



**MT** MATT

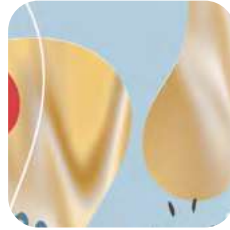

**H** HOLOGRAPHIC SILVER GOLD



**P** PUFFY



**M** METALLIC



**UV** UV



**PG** PUFFY GLITTER

2452

BIC® J38 BRIQUET DIGITAL  
2452



57

**BR** BRILLIANT



57

**MT** MATT



57

**MT** MATT

**H** HOLOGRAPHIC GOLD

impression  
360°

100%

Personnalisation

2452

**BIC® J38 BRIQUET DIGITAL**

2452

**A DG:** Numérique

Commande minimale 600 u.

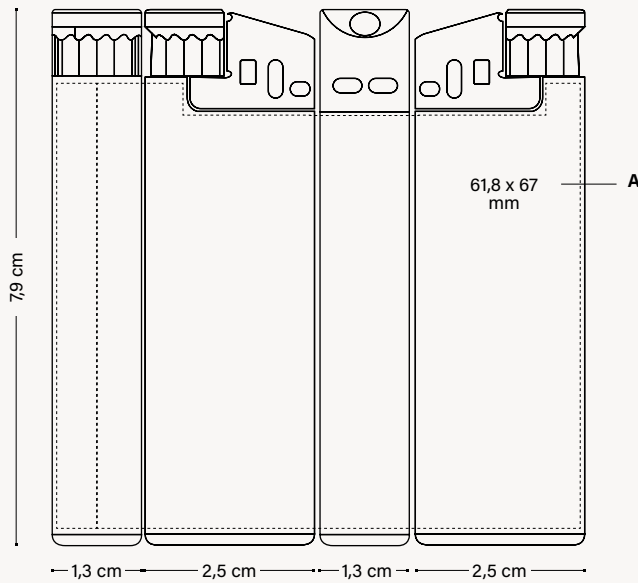

TECHNIQUES D'IMPRESSION



DURABILITÉ



EMBALLAGE



100% recyclé !

EMBALLAGE STANDARD :  
BARQUETTE DE 50 U.

EMBALLAGE EXTERNE



600 ± 13,2 KG



FSC ET CARTON  
RECYCLABLE

2386

**BIC® STYL'IT LUXURY ÉTUI**  
2386 Neon



*Tous les étuis sont livrés avec un briquet blanc BIC® J25 !*



59



1G



5C

100%

## Personnalisation

2386

**BIC® STYL'IT LUXURY ÉTUI**  
2386



TECHNIQUES  
D'IMPRESSION



TAMPOGRAPHIE



LASER

DURABILITÉ



Commande minimale 100 u.  
**A/C LE**

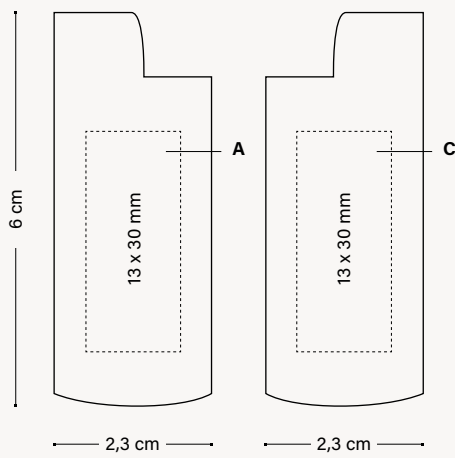

Commande minimale 300 u.  
**A/C PD**

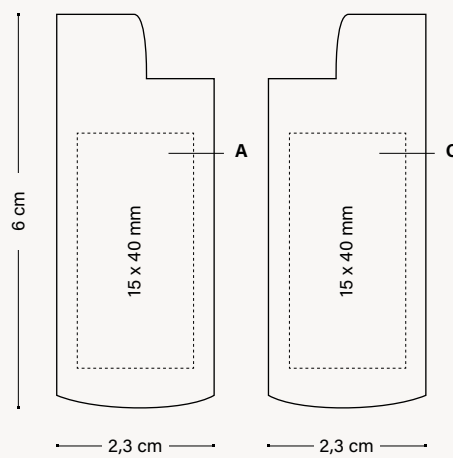

### EMBALLAGE



EMBALLAGE STANDARD:  
BOÎTE DE 10 U.

### EMBALLAGE EXTERNE



300 ± 6,1 KG



FSC ET CARTON  
RECYCLABLE

Consultez les pages 274-277 pour une explication détaillée des icônes.

# BIC® ALUMINIUM FLAT ÉTUI

2156

**BIC® ALUMINIUM FLAT ÉTUI**  
2156

3 faces  
personnalisables !



Tous les étuis sont  
livrés avec un briquet  
blanc BIC® J25 !



100%

47

## Personnalisation

2156

**BIC® ALUMINIUM FLAT ÉTUI**  
2156

Commande minimale 100 u.  
**A/C PD:** max. 1 col.

Commande minimale 100 u.  
**A/B/C BP:** Numérique

Commande minimale 100 u.  
**A/B/C LE**

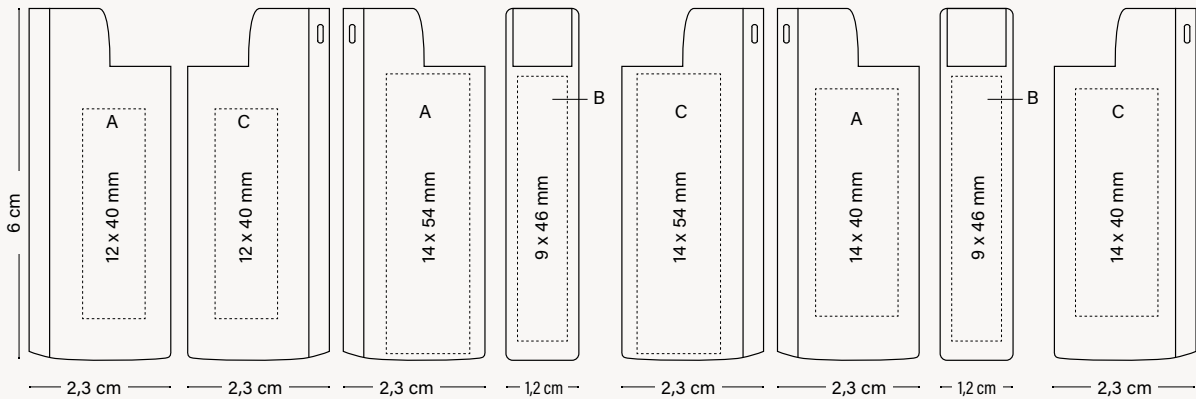

### EMBALLAGE



EMBALLAGE STANDARD:  
BOÎTE DE 50 U.

### EMBALLAGE EXTERNE



300 ± 75 KG



FSC ET CARTON  
RECYCLABLE



IMPRIMÉ DANS  
LES USINES BIC



RESPECTANT  
LES NORMES

### TECHNIQUES D'IMPRESSION



TAMPOGRAPHIE



BRITEPIX™  
BRITEPIX™ PERSONALISATION



LASER

### DURABILITÉ



2156

**BIC® CLIP ÉTUI**  
2398



Tous les étuis sont livrés avec un briquet blanc BIC® J2S !



## Personnalisation

2398

**BIC® CLIP ÉTUI**  
2398

Commande minimale 100 u.  
**A/C PD:** max. 1 col.

Commande minimale 100 u.  
**A/C BP:** Numérique  
**BP Texture:** Numérique

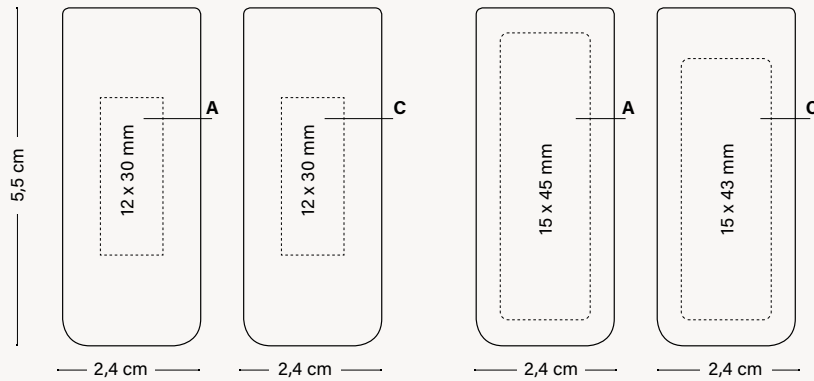

### EMBALLAGE



EMBALLAGE STANDARD:  
BOÎTE DE 50 U.

### EMBALLAGE EXTERNE



300 ± 75 KG



FSC ET CARTON  
RECYCLABLE



IMPRIMÉ DANS  
LES USINES BIC

Conform  
**ISO 9994**



RESPECTANT  
LES NORMES

Conform  
**EN 13869** 85%

### TECHNIQUES D'IMPRESSION

**PD**

TAMPOGRAPHIE

**BP**

BRITEPIX™  
BRITEPIX™ PERSONALISATION

### DURABILITÉ

**IMPRIM'VERT®**

2395

BIC® 3D ÉTUI  
2395



Tous les étuis sont livrés  
avec un briquet blanc  
BIC® J25 !



Convertissez  
votre logo en  
3D !

100%



2395

**BIC® 3D ÉTUI**

2395

A/C 3D: max. 6 col.

Commande minimale 1.200 u.



RESPECTANT  
LES NORMES



TECHNIQUES  
D'IMPRESSION



EMBOSSING

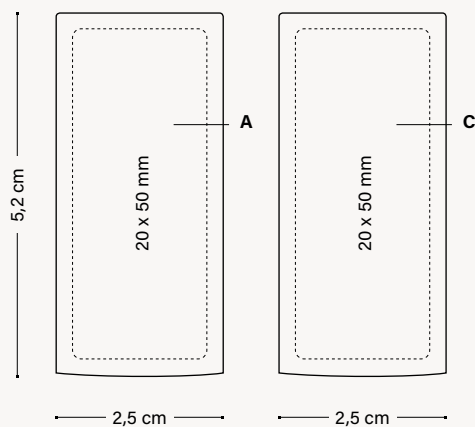

**EMBALLAGE**



EMBALLAGE STANDARD:  
BOÎTE DE 50 U.

**EMBALLAGE EXTERNE**



300 ± 75 KG



FSC ET CARTON  
RECYCLABLE

BIC® EZ REACH™

NOUVEAU !

# Illuminez vos moments uniques.



Les occasions de profiter d'une flamme en toute sécurité sont infinies, grâce au nouveau BIC® EZ Reach™.



BIC® EZ REACH™

# FLAMME SÛRE

Les doigts restent éloignés de la flamme.



Longue durée de vie, jusqu'à 900 allumages

**Flamme stable**  
grâce au gaz isobutane pur



**Format pratique**  
Il se glisse facilement dans la poche



Fabriqué en Europe



Pratique pour différentes situations  
requérant une flamme



Sûr et fiable



Maintient les doigts éloignés de la flamme  
grâce à sa tige de 3,5 cm

Système d'allumage très puissant



Produit avec 100 % électricité  
d'énergie renouvelable

**Grande résistance**  
Fabriqué en résine à forte  
résistance mécanique Delrin®



NOUVEAU !

# Les moments les plus particuliers commencent lorsque quelqu'un allume la flamme.



2450

BIC® EZ REACH™

2450

A SP: max. 1 col.

B BP: Numérique

Commande minimale 240u.



01

02

03



12

25

04

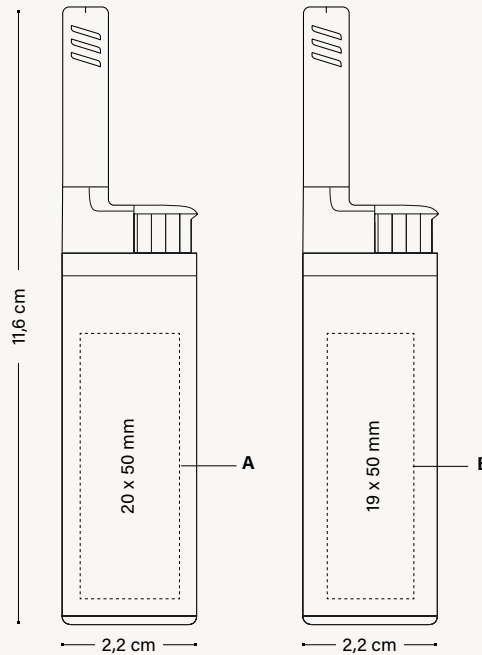

## EMBALLAGE



EMBALLAGE STANDARD :  
BARQUETTE DE 20 U.

## EMBALLAGE EXTERNE



120 ± 3.05 KG



FSC ET CARTON  
RECYCLABLE



IL SE GLISSE FACILEMENT  
DANS LA POCHE

## TECHNIQUES D'IMPRESSION



## DURABILITÉ



100 % DE L'ÉLECTRICITÉ  
PROVIENT DE SOURCES  
RENOUVELABLES



# BIC® CENDRIER DE POCHE

3850

**BIC® CENDRIER DE POCHE**  
3850

6 formes à  
rabat  
disponibles

Réutilisable et  
hermétique



Personnalisation

3850

**BIC® CENDRIER DE POCHE**  
3850

**A SP:** max. 5 col. (2 couleurs max.  
pour les commandes inférieures à  
20.000u.)

Commande minimale 5.000 u.

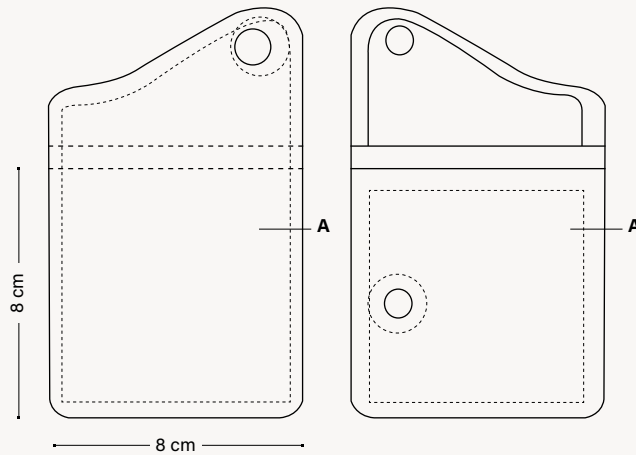

## EMBALLAGE



BOÎTE DE 10 UNITÉS.  
CHAQUE CENDRIER DE  
POCHE BIC® EST MIS SOUS  
EMBALLAGE INDIVIDUEL  
(CELLOPHANE).

## EMBALLAGE EXTERNE



500 ± 5,5 KG



RESPECTANT  
LES NORMES

## TECHNIQUES D'IMPRESSION



SÉRIGRAPHIE

3851

**BIC® CENDRIER DE POCHE**  
3851 Kraft



6F

Personnalisation

3851

**BIC® CENDRIER DE POCHE KRAFT**  
3851 Kraft

**A SP:** max. 2 col.

Commande minimale 10.000 u.

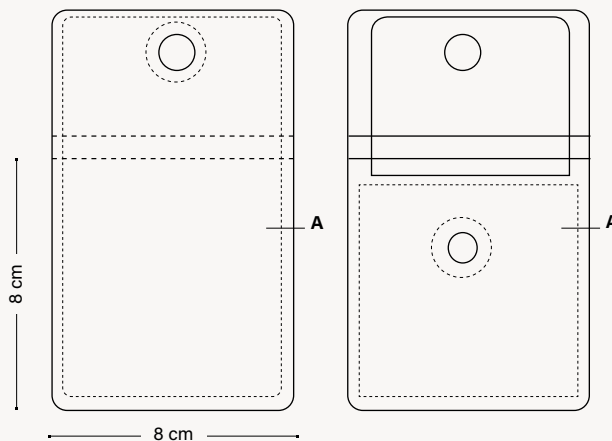

**EMBALLAGE**



BOÎTE DE 10 UNITÉS.  
CHAQUE CENDRIER DE  
POCHE BIC® EST MIS SOUS  
EMBALLAGE INDIVIDUEL  
(CELLOPHANE).

**EMBALLAGE EXTERNE**



500 ± 5,5 KG



RESPECTANT  
LES NORMES

**TECHNIQUES D'IMPRESSION**



SÉRIGRAPHIE



# BRIQUETS DJEEP®

**Durable et conçu avec style. Le briquet DJEEP® est créé pour fonctionner parfaitement. Chaque briquet est entièrement testé pour s'assurer qu'il répond à nos critères de qualité les plus stricts.**



**DJEEP® D1 BRIQUET**





**Ignite your  
mark.**

---

We are  
**premium**

We are  
**singular**



We are  
**engaged**

We are  
**creative**

# DJEEP® D1 BRIQUET

Durable et conçu avec style. Le briquet DJEEP® est créé pour fonctionner parfaitement. Chaque briquet est entièrement testé pour s'assurer qu'il répond à nos critères de qualité les plus stricts.



**FLAMME STABLE**  
grâce au gaz isobutane pur



**UN BRIQUET CONÇU  
POUR DURER**  
grâce à sa technologie à trois  
réservoirs



**RÉSERVOIR TRÈS  
RÉSISTANT**  
en résine à forte résistance  
mécanique



**GRAND POUSSOIR**  
pour un meilleur confort d'utilisation



**EFFETS HAUT DE GAMME**  
QUALITÉ DE FABRICATION  
conforme aux normes de sécurité  
internationales. Fabriqué en France



**FORME RECTANGULAIRE UNIQUE**  
pour une bonne tenue en main et une grande  
surface d'expression

**SÉCURITÉ ENFANTS**  
conforme à la norme EN 13869



# Décoration numérique 360°

DJEEP® propose une grande variété d'effets d'impression numérique. Pour doter chaque briquet d'une personnalité, vous avez le choix entre touch & feel, glossy & matt mix, etched, Holographik©...

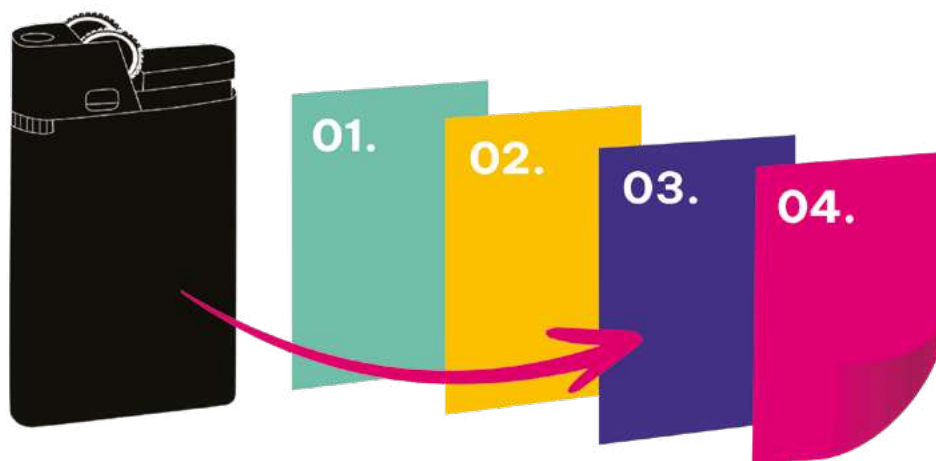

**01. Base.** Choisissez entre :  
 WM BLANC MOYEN  M ARGENT MÉTALLIQUE  H HOLOGRAPHIQUE

**02. Impression :** Nous choisissons la meilleure option pour vous (numérique, offset, flexographie, sérigraphie) en fonction des quantités et des options de design.

**03. Finition.** Choisissez entre :  
 G GLOSSY  MT MAT  ST DJEEP SOFT TOUCH®

**04. Options de décoration.** Choisissez jusqu'à 2 options de décoration différentes entre : GRANITE, FABRIC, DJEEP® SOFT TOUCH®, RESIN CHIP, TOUCH&FEEL, GLOSSY & MATT MIX, BLACK LIGHT, HAMMERED METAL, GLITTERING, FRAGRANT INK, GLOW IN THE DARK, ETCHED, QR CODE, HOLOGRAPHIK®, PEARLESCENT.

---

## POSSIBILITÉS DE DÉCORATION

---



ST

### DJEER® SOFT TOUCH®

Offrez une sensation de douceur unique ! Des tons profonds et une surface douce pour vivre une expérience exclusive.



GT

### GLITTERING

Ajoutez un effet scintillant à votre design ! Rendez vos couleurs vibrantes !



HM

### HAMMERED METAL

Un fond métallisé avec un motif effet en relief. Un look et une sensation vraiment premium pour se démarquer !



TF

### TOUCH & FEEL

Donnez un effet gaufré à votre design !



## POSSIBILITÉS DE DÉCORATION

---



ET

### ETCHED

Donnez un effet gravé au briquet !  
Créez des motifs et convertissez votre idée en un design élégant.

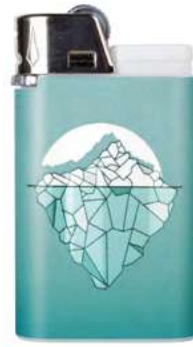

GM

### GLOSSY & MATT MIX

Choisissez cette finition pour créer des distinctions entre le mat ou DJEEP® Soft Touch© et le vernis UV qui donne de la vivacité aux couleurs.



FI

### FRAGRANT INK

Collez l'étiquette et profitez du parfum !  
Parfums disponibles :  
Menthe, Fruits rouges,  
Mojito, Citron vert et  
Ananas.



QR

### QR CODE

Redirigez votre client vers un site Web, un numéro de téléphone ou un message.  
Créez de l'interactivité entre le briquet et votre message !



BL

### BLACK LIGHT

Sous la lumière noire les couleurs fluorées apparaissent.  
Vous pouvez avoir des couleurs bleu clair, rouge, vert et jaune.



## POSSIBILITÉS DE DÉCORATION



FA

### FABRIC

Donnez l'aspect et le toucher d'une texture de tissu avec du relief et une finition mate !



RC

### RESIN CHIP

Ajoutez du volume à votre design !  
Donnez au briquet une troisième dimension !



GR

### GRANITE

Ajoutez une sensation granuleuse au briquet !



GD

### GLOW IN THE DARK

Exposez le briquet DJEEP® sous une ampoule ou directement au soleil et observez la poudre photoluminescente sur les endroits sombres ! Faites briller votre design dans le noir !



H

### HOLOGRAPHIK®

Une surface argentée réfléchissante pour montrer la haute qualité et l'innovation !



PE

### PEARLESCENT

Brillant nacré et subtil qui transmet de l'élégance et de la délicatesse !

# DJEEP® BRIQUET

---

08D1

**DJEEP® D1 BRIQUET**  
08D1

Commande minimale 10.000 u.



**MIX &  
MATCH**

---

## Capot

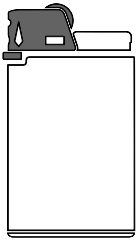

47

02

26

6E

---

## Poussoir

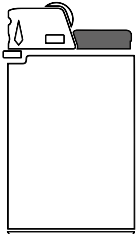

01

02

03

04

---

## Réservoir

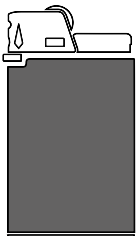

01

02

## Personnalisation

08D1

### DJEEP® D1 BRIQUET

08D1

A DG: Numérique

Commande minimale 10.000 u.

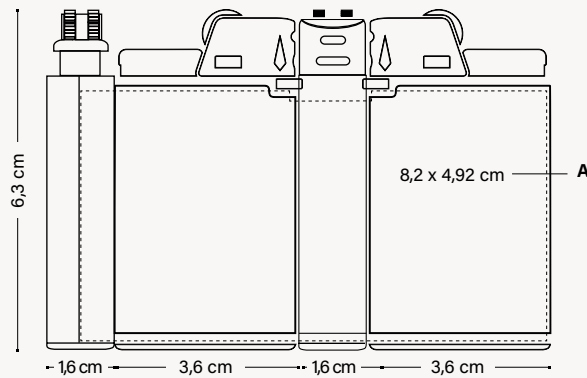

MIX &  
MATCH



FABRIQUÉ ET  
IMPRIMÉ DANS  
LES USINES DJEEP

FABRIQUÉ  
EN FRANCE



RESPECTANT  
LES NORMES



JUSQU'À 3500

Conform  
ISO 9994

Conform  
EN 13869

TECHNIQUES  
D'IMPRESSION

DG  
DIGITAL

DURABILITÉ



100 % DE L'ÉLECTRICITÉ  
PROVIENT DE SOURCES  
RENOUVELABLES

### EMBALLAGE



EMBALLAGE STANDARD:  
BOÎTE DE 10 U.

Carton recyclable

### EMBALLAGE EXTERNE



600 ± 20 KG



FSC ET CARTON  
RECYCLABLE

BIC  
GRAPHIC

INSTRUMENTS  
D'ÉCRITURE BIC®

AUTRES INSTRUMENTS  
D'ÉCRITURE

CARNETS

BRIQUETS BIC®/DJEEP®  
ET ÉTUIS BIC®

EMBALLAGES  
BIC®

INFORMATIONS  
GÉNÉRALES

Consultez les pages 274-277 pour une explication détaillée des icônes.

Index

**EMBALLAGES**

**BIC®**

---

**05**

Emballages BIC® Ecolutions®	262
Emballages BIC®	264

529294

**BIC® COLLECTION BOX SLIM PENS 4 UNITÉS**

Emballage en carton FSC. Personnalisable sur chaque face offrant de belles surfaces de communication. Idéal pour proposer nos produits iconiques BIC® à travers une collection. Plus qu'un stylo, un excellent moyen d'optimiser vos ventes.



FSC ET CARTON RECYCLABLE

**NOUVEAU !**



Emballage spécial pour:



- BIC® CRISTAL® EXPRESSION**
- BIC® ROUND STIC®**
- BIC® STYLE**
- BIC® CLIC STIC**

100% personnalisable à partir de 250 unités !

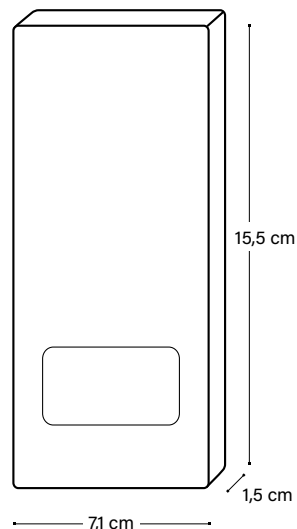

991212 / 991213 / 991214

**BIC® COLLECTION BOX**

Emballage en carton FSC. Personnalisable sur chaque face offrant de belles surfaces de communication. Idéal pour proposer nos produits iconiques BIC® à travers une collection. Plus qu'un stylo, un excellent moyen d'optimiser vos ventes.



FSC ET CARTON RECYCLABLE

- 991212 - 1 unité
- 991213 - 2 unités
- 991214 - 3 unités

Emballage spécial pour :



- BIC® 4 COULEURS®**
- BIC® WIDE BODY™**
- BIC® SUPER CLIP**
- BIC® BRITE LINER® GRIP**
- BIC® GRIP ROLLER**

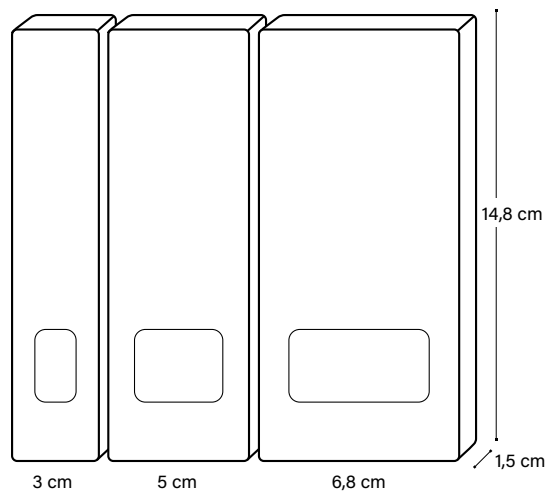

985240

**BIC® ECO SLEEVE**

Pochette spéciale recyclée pour tous les instruments d'écriture BIC® à l'exception des crayons à papier.



Emballage spécial pour:



- BIC® MEDIA CLIC
- BIC® CLIC STIC
- BIC® SUPER CLIP
- BIC® WIDE BODY™
- BIC® INTENSITY® GEL CLIC
- BIC® XS FINE STYLE

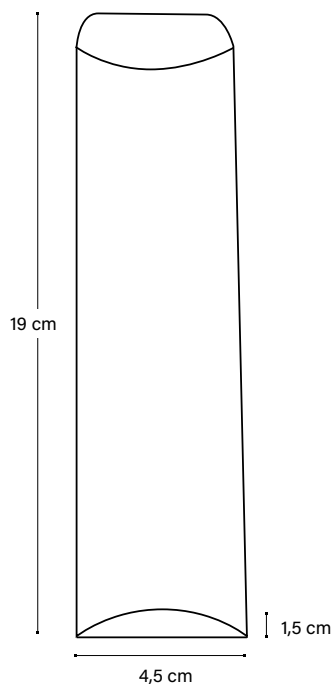

DURABILITÉ



985241

**BIC® WINDOW BOX**

Emballage design haut de gamme pour tous les instruments d'écriture BIC® à l'exception des crayons à papier.



Emballage spécial pour :



**BIC® METAL PENS**

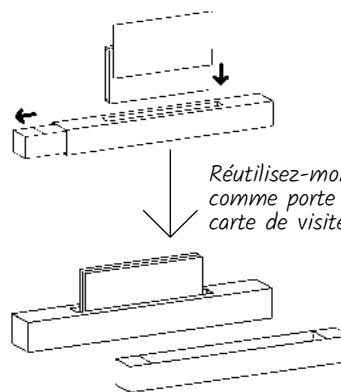

BIC GRAPHIC

INSTRUMENTS D'ÉCRITURE BIC®

AUTRES INSTRUMENTS D'ÉCRITURE

CARNETS

BRIQUETS BIC®/DIEEP® ET ÉTUIS BIC®

EMBALLAGES BIC®

INFORMATIONS GÉNÉRALES

Consultez la page 274-277 pour une explication détaillée des icônes



# BIC® EMBALLAGES

985242

## BIC® PLASTIC POUCH

Design spécial pour cet emballage qui s'adapte à tous les instruments d'écriture et pour 3 crayons à papier.



Utilisez-moi comme  
marque-page

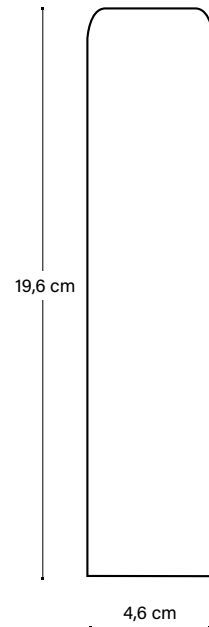

985243

## BIC® MARKING SET

Emballage conçu pour tous les types de marqueurs.



16 cm

6,3 cm

Emballage spécial pour stylos avec clip imprimé :



3 BIC® BRITE LINER® GRIP  
3 BIC® MARK-IT



3 BIC® VELLEDA® GRIP  
3 BIC® VELLEDA® FINE

Utilisez-moi comme  
marque-page



971634 / 971635 / 971636 / 971637

## BIC® CELLO WRAP

Emballage enveloppe en matière plastique résistante et transparente.

- 971634 - 1 unité
- 971635 - 2 unités
- 971636 - 3 unités
- 971637 - 4 unités



Cello wrap 1 unité



Cello wrap 2 unités

974216

**BIC® BLACK VELVET POUCH 1 ARTICLE**

Emballage exclusif en velours pour 1 instrument d'écriture.  
Spécialement recommandé pour les stylos métal.

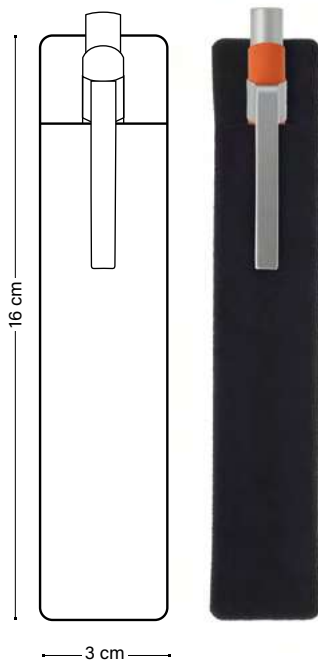

971640

**BIC® FROSTED POUCH (POUR 1 OU 2 ARTICLES)**

Emballage transparent pour 2 instruments d'écriture.

A SP: max. 1 col.

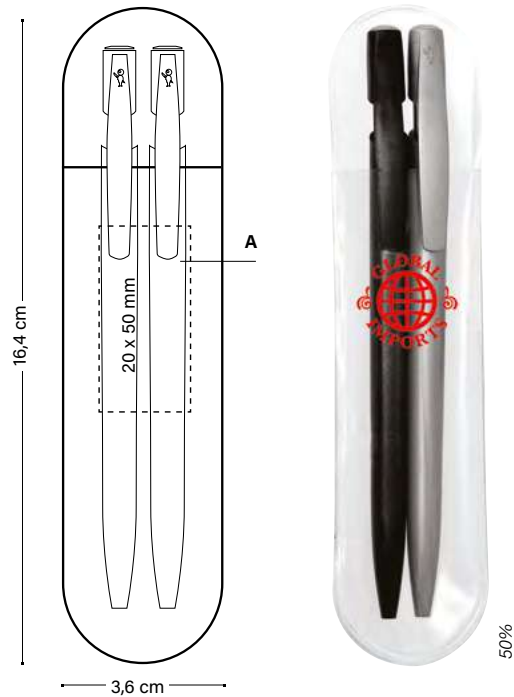

SP SÉRIGRAPHIE

974599

**BIC® SEE-THROUGH GIFT BOX (POUR 1 OU 2 ARTICLES)**

Boîte pour tous les instruments d'écriture,  
sauf les crayons à papier.

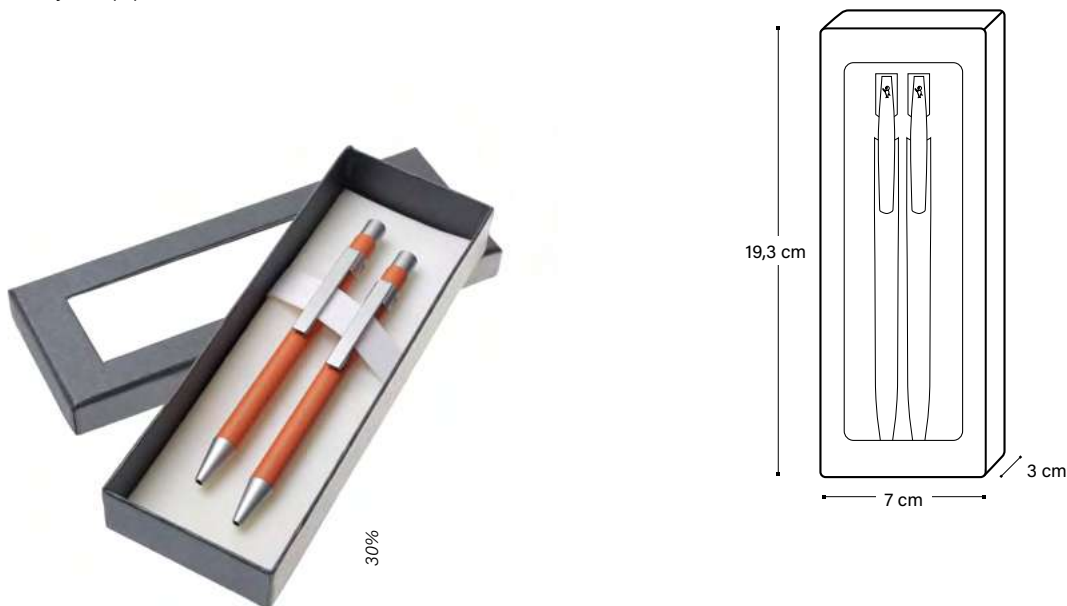

BIC GRAPHIC

INSTRUMENTS D'ÉCRITURE BIC®

AUTRES INSTRUMENTS D'ÉCRITURE

CARNETS

BRIQUETS BIC®/DIEEP® ET ÉTUIS BIC®

EMBALLAGES BIC®

INFORMATIONS GÉNÉRALES

971639 / 971638 / 971672

## COUNT BOX

**Petit** (pour 25 BIC® Clic Stic) - 6 x 6,2 x 14 cm  
971639

**Moyen** (pour 50 BIC® Media Clic ou Stylo BIC® de mêmes dimensions) - 7,5 x 7,5 x 15,2 cm  
971638

**Grand** (uniquement pour 100 BIC® Evolution® Ecolutions®) - 7,5 x 7,5 x 19 cm  
971672



971644 / 971643 / 971642

## PLASTIC BAG

**Petit** (pour 25 BIC® Media clic ou Stylo BIC® de mêmes dimensions)  
971644 - 12 x 18 cm

**Moyen** (pour 50 BIC® Media clic ou Stylo BIC® de mêmes dimensions)  
971643 - 15 x 22 cm

**Grand** (pour 100 BIC® Media clic ou Stylo BIC® de mêmes dimensions)  
971642 - 30 x 40 cm



974590

## TRAY OF 10 WRITING INSTRUMENTS

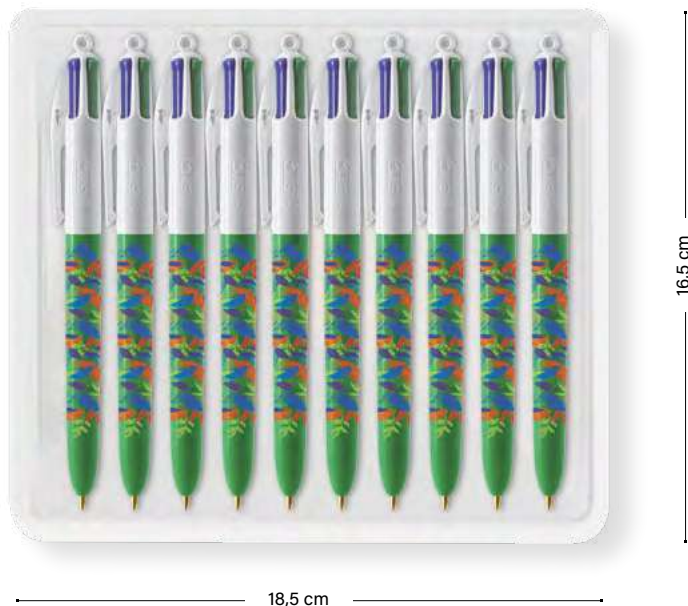

976382

COUNT BOX 10U. ÉTUIS



976403

COUNT BOX 10U. ÉTUIS CHILD RESISTANT



974635

COUNT BOX 10U. J25 CHILD RESISTANT



977852

BOX OF 50U. METAL STYL'IT ÉTUI



BARQUETTE DE 50 BRIQUETS BIC®



TRAY OF 20U. BIC® EZ REACH™ LIGHTERS



BARQUETTE DE 10 BRIQUETS DJEEP®

CARTON RECYCLABLE



BIC® OUTER BOXES

Dessin spécial pour toutes les boîtes extérieures en lien avec tous les instruments d'écriture.



BIC® OUTER BOXES

Dessin spécial pour les boîtes de briquets.



DJEEP® OUTER BOXES

Dessin spécial pour les boîtes de briquets.



Index

# INFORMATION GÉNÉRALE

---

---

Commandez en toute simplicité !	270
Symboles et abréviations	274
Informations générales	276
Index des produits	277
Nuancier de Couleurs	278

**Commandez en toute simplicité !**

---

# **GAGNEZ DU TEMPS LORS DU CALCUL DE VOTRE PRIX FINAL**

REGARDEZ LA COLONNE DE QUANTITÉ POUR LE PRIX  
ET C'EST TOUT !



**SANS FRAIS TECHNIQUES NI FRAIS D'ÉCRAN**

## **PERSONNALISATION INCLUSE**

Les prix comprennent la personnalisation sur une position.

## **COULEUR PANTONE POUR LES ATTRIBUTS**

- Un choix "illimité" de couleurs de corps et d'attributs à partir de 10.000 pièces.
- Un stylo entièrement personnalisé dans les couleurs que vous souhaitez.
- Disponible avec une large gamme de produits.
- Un service supplémentaire à forte valeur ajoutée avec un court délai additionnel de production.
- Disponible pour les corps et attributs de : BIC® Round Stic®, BIC® Media Clic, BIC® Media Clic Grip\*, BIC® Clic Stic, BIC® Super Clip, BIC® Wide Body™, BIC® XS Finestyle

\* Pour un corps et grip personnalisés MOQ de 20.000 pièces.

## **COÛTS SUPPLÉMENTAIRES**

\* Non disponible pour les briquets numériques avec finitions Puffy, Puffy Glitter, Metallic, Holographic et UV.

\*\* britePix™ personnalisation individuelle vous permet de changer les textes et image de votre photomontage, vous offrant un marquage personnalisé sur chacun des produits de votre commande. Toute information ou image devra être fournie sous un fichier Excel. En cas de modification de la position des textes et images (par rapport à la zone standard) un supplément sera facturé.

**Pour les conditions générales de vente, veuillez vous référer à [www.bicgraphic.com](http://www.bicgraphic.com)**





BIC® Clic Stic



BIC® 4 Couleurs®



BIC® Media Clic

## INFORMATIONS CONCERNANT LES FICHIERS

Veillez charger votre fichier sous l'un des formats suivants:

- Un fichier électronique avec le dessin graphique
- Et un fichier différent pour le texte. Pour un marquage au laser individuel, les textes devront être fournis uniquement sous format Excel® (.xls)

## PROPRIÉTÉS DU MATÉRIEL GRAPHIQUE

Envoyez-nous votre matériel graphique dans un des types de fichiers suivants :

- JPG / 350 dpi non comprimé à la taille réelle de marquage (seulement images, sans texte)
- PDF / vectorisé
- Illustrator® CC / vectorisé
- Photoshop® CC / avec les calques
- Fichiers ZIP

Il est important que vous nous fassiez parvenir les informations dans l'un de ces formats afin de traiter au mieux votre commande et d'obtenir un résultat final optimal. Si la création du client ne rentre pas dans notre format, nous la modifierons en conséquence.

## TYPE DE CARACTÈRES :

Tous les types de caractères doivent être convertis en image. Vérifiez les tailles minimales des types et les épaisseurs de trait. Veuillez contacter le service clientèle pour plus d'informations.

## SPÉCIAL POUR LES INSTRUMENTS D'ÉCRITURE

La zone d'impression disponible dépend de la technique d'impression requise.

### SÉRIGRAPHIE

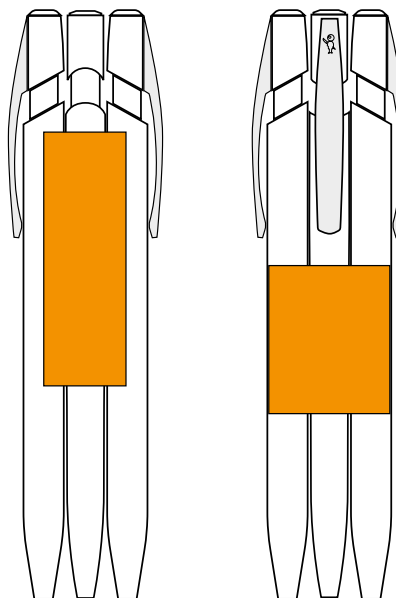

Clip arrière

Clip centré

## SPÉCIAL POUR LES BRIQUETS (J25, J23, J26 ET J38)

Pour toute demande de couleur directe Pantone, nous pouvons proposer une impression avec une 5ème couleur disponible dans ce catalogue, à un prix majoré. Pour plus d'informations sur la manière d'obtenir la couleur correspondante la plus proche pour des impressions sur différents produits de notre catalogue, veuillez contacter notre service client.

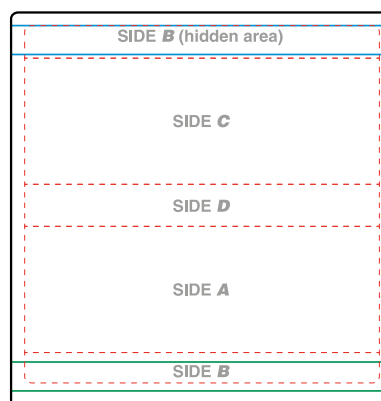

# Symboles et abréviations

## SYMBOLES DES TECHNIQUES D'IMPRESSION



**Puffy glitter**  
Texture avec paillettes colorées.



**Puffy Printing**  
Une personnalisation soulignée par notre encre « Puffy », pour donner un effet de relief à votre logo.



**BR**  
Finition brillante.



**Metallic Finish**  
Crée des effets métalliques sur les images ou l'arrière-plan.



**Holographic Finish**  
Crée des effets attractifs en or ou argent.



**Matt**  
Finition mate.



**UV**  
Finition extra brillante.



**Hot Stamping**  
Graver en relief sensible au toucher.



**Impression 360° degrés**



**Impression 360° degrés**



impression 360°

**Digital**  
Quadrichromie haute définition, à 360° degrés et sur toute la longueur du corps.



**britePix™ Digital**  
La solution pour une communication tout en couleur. Maintenant sur des corps en couleur.



**britePix™ Texture**  
BritePix™ Texture apporte une nouvelle touche haut de gamme au concept britePix™. Désormais, vous pouvez non seulement voir tout en couleur, mais aussi le toucher !



**britePix™ personalisation**  
Personnalisez chaque unité dans une seule et même commande.



**Sérigraphie**



**Gravure laser**



**Tampographie**



**Quadrichromie**



**britePix™**



**3D embossage**



**Debossing**



**Touch & feel**



**Etched**



**Glossy & matt mix**



**Fragrant ink**



**QR code**



**Black light**



**Fabric**



**Resin chip**



**Granite**



**Glow in the dark**



**Holographik®**



**Pearlescent**



**Djeep® soft touch®**



**Glittering**



**Hammered metal**

## MODES D'ÉCRITURE



**Bille** | M Medium 1 mm  
F Fine



**Porte-mine MP**



**Crayon PC**



**Stylo à bille roulante R**



**Marqueur HL**



**Embout caoutchouc SP**



**Feutre pointe fine FS**  
Ø 0,7mm



**Gel G**



**Marqueur pointe ogive MK**



**Pointe résistante**



**Pas d'échardes en cas de brisure**



**Facile à utiliser et à effacer**



**Écriture plus douce et foncée**



**Écriture plus douce et fluide**



**Résiste aux chocs**



**Ne sèche pas**



**Protecteur de mine**















**2 mines**

## COULEURS D'ENCRE

- Noir
- Vert clair
- Bleu clair
- Vert pomme
- Bleu foncé
- Vert foncé
- Rouge
- Fluo
- Orange
- Rose
- Jaune
- Violet

## AUTRES SYMBOLES

	<b>Nouveau</b>		<b>FSC et carton recyclable</b> Produit fabriqué avec des matériaux respectant l'environnement, utilisant des matériaux renouvelables de conifères (polymères cellulosiques).		<b>Réduction virale 93% en 24h</b>
	<b>Mix&amp;Match</b> Des centaines de couleurs de composants en stock pour la personnalisation complète des instruments d'écriture.				<b>Protection sur toute la surface du stylo</b>
	<b>Couleurs personnalisées</b> Choisissez la couleur exacte pour des décorations les mieux adaptées à votre logo.		<b>Emballages pharmaceutiques</b>		<b>Protection à vie</b>
	<b>Fabriqué et imprimé dans les usines BIC</b>		<b>Cageots de fruits et légumes</b>		<b>Protection antibactérienne</b>
	<b>Fabriqué dans les usines BIC</b>		<b>Réfrigérateurs et pots de yaourt</b>		<b>Inhibition des champignons en 24h</b>
	<b>Imprimé dans les usines BIC</b>		<b>Canne à sucre</b>		<b>Respectant les normes</b>
	<b>Montage et impression dans les usines DJEEP</b>		<b>Pièces automobiles en plastique</b>		<b>EN 13869</b> Règlement de sécurité des enfants pour les briquets.
	<b>Montage et impression dans les usines BIC</b>		<b>100% Électricité d'énergie renouvelable</b> L'usine BIC Graphic Europe s'alimente 100% d'électricité renouvelable.		<b>Certification ISO</b>
	<b>Qualité et sécurité approuvées</b>		<b>Imprim'vert</b> Certification pour des pratiques d'impression respectueuses de l'environnement.		<b>ISO</b> Normes internationales de sécurité
	<b>Pays d'origine</b>		<b>Möbius Loop</b> Le produit contient des matériaux recyclés.		<b>Nombre d'allumages</b>
	<b>Fabriqué en France</b>		<b>Faible impact environnemental</b> Les produits sont fabriqués et imprimés dans des usines européennes où 100% de l'électricité utilisée provient de sources renouvelables.		<b>Gardez les doigts loin de la flamme</b>
	<b>Fabriqué en Espagne</b>		Le partenariat TerraCycle® permet de recycler les instruments d'écriture BIC en France		<b>Se glisse facilement dans la poche</b>
					<b>Code QR</b> Scannez le QR code
					<b>Informations sur l'emballage</b>
					<b>250 ± 3,5 KG</b>
					<b>DIMENSIONS :</b> Les dimensions publiées de tous les produits correspondent à la taille maximale, quelle que soit la position du dessin.

# Informations générales

## PARAMÈTRES TECHNIQUES POUR CHACUN DES TYPES D'IMPRESSION

	NUMÉRIQUE / TRANSFERT DIGITAL	
Texte positif minimum	4 pt (1.4 mm)	<small>4 Point text</small>
Texte négatif minimum	7 pt (2.4 mm)	<b>7 Point text</b>
Texte minimum pour les demi-tons	1.5 pt (0.5 mm)	7 Point text
Épaisseur minimale des lignes positives	0.25 pt (0.08 mm)	—————
Épaisseur minimale des lignes négatives	0.5 pt (0.17 mm)	—————
Épaisseur minimale des demi-teintes	0.5 pt (0.17 mm)	—————
Valeurs minimales des demi-teintes	C: 8% / M: 8% / Y: 12% / K: 8% 	

	britePix™	
Texte positif minimum	6 pt (2.1 mm)	<small>6 Point text</small>
Texte négatif minimum	7 pt (2.4 mm)	<b>7 Point text</b>
Épaisseur minimale des lignes positives	0.4 pt (0.14 mm)	—————
Épaisseur minimale des lignes négatives	0.5 pt (0.17 mm)	—————
Épaisseur minimale des demi-teintes	1 pt (0.35 mm)	—————
Pourcentage de demi-teinte		

	SÉRIGRAPHIE	HOT STAMPING / EMBOSSAGE	LASER
Texte positif minimum	6 pt (2.1 mm) <small>6 Point text</small>	10 pt (3.5 mm) <b>10 Point text</b>	6 pt (2.1 mm) <small>6 Point text</small>
Texte négatif minimum	9 pt (3.1 mm) <b>9 Point text</b>	15 pt (5.25 mm) <b>15 Point</b>	NON RECOMMANDÉ
Épaisseur minimale des lignes positives	0.4 pt (0.14 mm) —————	1.5 pt (0.5 mm) —————	0.3 pt (0.1 mm) —————
Épaisseur minimale des lignes négatives	0.5 pt (0.176 mm) —————	2 pt (0.706 mm) —————	0.5 pt (0.17 mm) —————
Épaisseur minimale des demi-teintes	1.5 pt (0.5 mm) —————	PAS POSSIBLE	PAS POSSIBLE
Pourcentage de demi-teinte	50% —————		

## INSTRUMENTS D'ÉCRITURE BIC®

BIC® Cristal® Expression _____	40
BIC® Cristal® Re'New™ _____	44
BIC® Style _____	48
BIC® Round Stic® _____	52
BIC® Round Stic® BGuard™ antibactérien _____	54
BIC® Round Stic® Ecolutions® _____	55
BIC® M10® Clic _____	58
BIC® Media Clic _____	62
BIC® Media Clic Ecolutions® _____	63
BIC® Media Clic Grip _____	65
BIC® Media Clic BGuard™ antibactérien _____	72
BIC® Media Clic BGuard™ antimicrobial Ecolutions® _____	74
BIC® Media Clic Biobased Ecolutions® _____	76
BIC® Media Clic Biobased BGuard™ antibactérien _____	80
BIC® Media Clic Shine _____	82
BIC® Media Clic Glacé _____	84
BIC® Clic Stic _____	86
BIC® Clic Stic Ecolutions® _____	87
BIC® Clic Stic Stylus _____	90
BIC® Clic Stic Stylus Ecolutions® _____	90
BIC® Super Clip _____	94
BIC® Super Clip Advance _____	100
BIC® Super Clip Glacé _____	104
BIC® Super Clip Glacé Advance _____	104
BIC® Super Clip Soft _____	106
BIC® Super Clip Soft Advance _____	106
BIC® Super Clip Origin _____	108
BIC® Wide Body™ _____	112
BIC® 4 Couleurs® _____	118
BIC® 4 Couleurs® Rainbow Decor _____	122
BIC® 4 Couleurs® Bicolor _____	124
BIC® 4 Couleurs® Gradient _____	126
BIC® 4 Couleurs® Pastel _____	128
BIC® 4 Couleurs® Fashion _____	130
BIC® 4 Couleurs® Sun _____	132
BIC® 4 Couleurs® Fine _____	134
BIC® 4 Couleurs® Fluo _____	136
BIC® 4 Couleurs® Glacé _____	138
BIC® 4 Couleurs® Shine _____	140
BIC® 4 Couleurs® Soft _____	142
BIC® 4 Couleurs® Wood Style _____	144
BIC® 4 Couleurs® Flags Collection _____	146
BIC® 4 Couleurs® 3+1 <sup>HB</sup> _____	148
BIC® Metal Pro _____	150
BIC® Grip Roller _____	156
BIC® XS Finestyle _____	158
BIC® Intensity® Gel Clic _____	160
BIC® Brite Liner® Grip _____	164
BIC® Velleda® White Board Marker Fine _____	166
BIC® Velleda® White Board Marker Grip _____	167
BIC® Mark-It Permanent Marker _____	168

BIC® Permanent Marker Ecolutions® _____	169
BIC® Matic® _____	172
BIC® Matic® Ecolutions® _____	172
BIC® Media Clic Porte-mines _____	174
BIC® Media Clic Grip Porte-mines _____	175
BIC® Media Clic Grip Ecolutions® Porte-mines _____	175
BIC® Evolution® Ecolutions® _____	180
BIC® Kids Colouring Set _____	184
Sprout™ Crayon Graphite _____	186

## AUTRES INSTRUMENTS D'ÉCRITURE

Basic Pen _____	190
Click Pen _____	192
Striped Grip Pen _____	194
Sleek Stylus Pen _____	198

## CARNETS

Rocketbook® Core Executive A5 _____	202
Rocketbook® Fusion Executive A5 _____	204
Rocketbook® Core Mini A6 _____	208

## MOLESKINE

Moleskine Classic Notebooks _____	210
Moleskine Cahier Journals _____	214

## BRIQUETS ET ÉTUIS BIC®

BIC® J25 Briquet _____	222
BIC® J23 Briquet _____	226
BIC® J26 Briquet _____	230
BIC® J38 Briquet _____	234
BIC® Styl'it Luxury Étui _____	238
BIC® Aluminium Flat Étui _____	240
BIC® Clip Étui _____	241
BIC® 3D Étui _____	242
BIC® EZ Reach™ _____	244
BIC® Cendrier de Poche _____	248

## BRIQUETS DJEEP®

Briquet DJEEP® _____	250
----------------------	-----

## EMBALLAGES BIC®

Emballages BIC® Ecolutions® _____	262
Emballages BIC® _____	264



# Nuancier de Couleurs

										
<b>01</b> Blanc	<b>1E</b> Blanc recyclé	<b>57</b> Blanc opaque	<b>3C</b> Blanc Bio	<b>01BIO</b> Blanc Bio	<b>1T</b> Blanc polished	<b>51</b> Transparent	<b>69</b> Blanc givré	<b>2E</b> Blanc givré recyclé		
										
<b>8D</b> Jaune pastel	<b>8G</b> Jaune léger	<b>12</b> Jaune	<b>12W</b> Jaune bois	<b>63</b> Jaune givré	<b>6AW</b> Bois naturel	<b>012BIO</b> Jaune Bio	<b>4D</b> Jaune clair	<b>6F</b> Marron clair	<b>60</b> Jaune pastel	
										
<b>9C</b> Inspiring Autumn	<b>26</b> Or	<b>76</b> Or glacé	<b>1G</b> Orange acide	<b>10</b> Orange	<b>90</b> Orange pastel	<b>71</b> Orange givré	<b>92</b> Orange clair			
										
<b>03</b> Rouge	<b>03G</b> Rouge glacé	<b>03F</b> Rouge doux	<b>8E</b> Rouge recyclé	<b>87</b> Rouge clair	<b>03BIO</b> Rouge Bio	<b>66</b> Rouge givré	<b>08</b> Bordeaux			
										
<b>14A</b> Peaceful Pink	<b>14</b> Rose pétillant	<b>5C</b> Rose pétillant	<b>1P</b> Rose fluo	<b>014G</b> Rose glacé	<b>07</b> Rose or	<b>11</b> Rose	<b>80</b> Rose	<b>97</b> Rose or	<b>98</b> Magenta	
										
<b>84</b> Pourpre pastel	<b>13</b> Lilas	<b>39</b> Pourpre givré	<b>7G</b> Violet métallisé	<b>2D</b> Pourpre	<b>93</b> Pourpre foncé clair	<b>4B</b> Pourpre givré	<b>2M</b> Violet foncé métallisé			
										
<b>8C</b> Citron vert	<b>68</b> Vert givré	<b>6C</b> Vert herbe	<b>88</b> Vert clair	<b>59</b> Vert pomme	<b>82</b> Vert foncé glacé	<b>72</b> Vert clair (clear)	<b>5G</b> Vert clair (opaque)	<b>05G</b> Vert glacé	<b>05</b> Vert métallique	
										
<b>05</b> Vert	<b>05W</b> Vert bois	<b>20</b> Vert foncé	<b>7E</b> Vert foncé recyclé	<b>88</b> Vert foncé clair	<b>05BIO</b> Vert Bio	<b>3B</b> Vert kaki givré				
										
<b>83</b> Bleu pastel	<b>4M</b> Cozy Blue	<b>3D</b> Bleu Caraïbes	<b>86</b> Bleu clair	<b>67</b> Bleu glacé	<b>24</b> Bleu clair	<b>04BIO</b> Bleu Bio	<b>04</b> Bleu	<b>04G</b> Bleu glacé	<b>40</b> Bleu foncé givré	<b>4R</b> Bleu turquoise
										
<b>34</b> Bleu métallisé	<b>89</b> Bleu marine clair	<b>7C</b> Bleu marine métallisé	<b>25</b> Bleu foncé	<b>07</b> Bleu marine	<b>07F</b> Bleu marine recyclé	<b>10E</b> Bleu marine recyclé				
										
<b>35</b> Chrome	<b>47</b> Argent	<b>47G</b> Argent glacé	<b>75</b> Argent métallisé	<b>18</b> Métal	<b>06</b> Gris clair	<b>27</b> Gris foncé	<b>8H</b> Gris foncé givré	<b>6W</b> Gris chaud		
										
<b>02BIO</b> Noir Bio	<b>02W</b> Noir bois	<b>02F</b> Noir doux	<b>02</b> Noir	<b>3E</b> Noir recyclé	<b>2N</b> Noir mat					





# LA MARQUE DES MARQUES RESPONSABLES

---



[www.bicgraphic.com](http://www.bicgraphic.com)

